

Machine safety

Prevention of mechanical hazards



Fixed guards and
safety distances

GUIDE RG-597

CSST

irsst

Machine safety

Prevention of mechanical hazards

**Fixed guards and
safety distances**

Research and writing

Laurent Giraud, Ph. D., junior engineer, researcher, Research Department, IRSST

Project management

Benoît Laflamme, engineer, prevention-inspection advisor, Direction de la prévention-inspection, CSST

Collaboration

Jean Desputeau, inspector, Direction régionale de l'Île-de-Montréal, CSST

Donald Duchesne, engineer, prevention-inspection consultant, Direction de la prévention-inspection, CSST

Gilles Gagnon, engineer, prevention-inspection consultant, Direction de la prévention-inspection, CSST

Pierre Guay, engineer, team leader in prevention-inspection, Direction régionale de la Yamaska, CSST

Benoît Laflamme, engineer, prevention-inspection consultant, Direction de la prévention-inspection, CSST

André Paillé, engineer, inspector, Direction régionale de Lanaudière, CSST

Conrad Trudel, ergonomist, team leader in prevention-inspection, Direction régionale de Longueuil, CSST

François Trudel, engineer, inspector, Direction régionale de l'Abitibi-Témiscamingue, CSST

Coordination

Catherine Bérubé, communications consultant, Direction des communications, CSST

Translation

Helen Fleischauer

Graphic design and computer graphics

Diane Urbain, Direction des communications, CSST

Mario Saucier, Studio M. Saucier inc.

Illustrations

Steve Bergeron

Original title:

Sécurité des machines - Prévention des phénomènes dangereux d'origine mécanique, protecteurs fixes et distances de sécurité

Acknowledgements

We want to thank the INRS for allowing us to use brochure ED 807 entitled *Sécurité des machines et des équipements de travail – Moyens de protection contre les risques mécaniques*; it served as the scientific basis for this document.

We also want to thank Réal Bourbonnière, engineer, for his contribution to writing the section on general risk-management principles based on IRSST guide R-405 entitled *Guide de conception des circuits de sécurité : introduction aux catégories de la norme ISO 13849-1:1999* (version corrigée).

© Institut de recherche Robert-Sauvé en santé et en sécurité du travail (IRSST) et Commission de la santé et de la sécurité du travail du Québec (CSST)

Legal deposit – Bibliothèque et Archives nationales du Québec, 2009

ISBN 978-2-550 (French version)

ISBN 978-2-89631-341-9

Preface

This guide mainly discusses the prevention of mechanical hazards. It describes methods for eliminating hazards at source or for reducing them, as well as ways to protect against them by using fixed guards.

The risk reduction or distance protection principles presented in the guide are general and are appropriate for the majority of machines. For some machines (for example, conveyors, metal presses, drills, rubber machines, etc.), before applying the generic solutions proposed in this guide, one should consult Québec regulations, standards relating to these machines (ISO, CSA, ANSI, etc.), or the technical guides published by the CSST (such as the guide *Sécurité des convoyeurs à courroie*), or by other organizations (ASP, INRS, IRSST, etc.), which can provide details on how to ensure the safety of these machines.

This guide is not an exhaustive collection of solutions, but it covers some of the currently known protection principles. For more information on machine safety, refer to the bibliography at the end of the document, or consult the Web site: www.centredec.csst.qc.ca.

Table of contents

Introduction 9

Section 1 General information 11

- 1.1 Plan of the guide 11
- 1.2 Current laws and regulations 12
- 1.3 Definitions of the terms used in this guide 14

Section 2 General risk-management principles 19

- 2.1 Risk assessment 20
 - 2.1.1 Risk analysis 20
 - 2.1.2 Risk evaluation 23
- 2.2 Risk reduction 24
 - 2.2.1 Hazard elimination and risk reduction 24
 - 2.2.2 Guards and protective devices 24
 - 2.2.3 Warnings, work methods and personal protective equipment 25
 - 2.2.4 Training and information 25
 - 2.2.5 Verification of the final result 25

Section 3 Guards 27

- 3.1 Fixed guards 28
- 3.2 Choice of type of guards 30

Section 4 Protection against crushing hazards 31

- 4.1 Protection using a minimum gap between the moving components 31
- 4.2 Protection by reducing the forces and energy levels of moving components 33

Section 5 Safeguarding by distance 35

- 5.1 Access by reaching upwards 35
- 5.2 Access by reaching over a fixed distance guard 36
- 5.3 Access by reaching through an opening in a guard 38
 - 5.3.1 Openings in the guard 38
 - 5.3.2 Tunnel guards 40
 - 5.3.3 Limiting movement 41
- 5.4 Access by reaching under a guard 41
 - 5.4.1 Lower and upper limbs 42
 - 5.4.2 Lower limbs only 43
 - 5.4.3 Limiting movement 43

Section 6 Protection of in-running nips 45

- 6.1 Creation of in-running nips 45
- 6.2 Delimiting the drawing-in zone 47
- 6.3 General information on the use of fixed nip guards 49
 - 6.3.1 Protection of two cylinders in contact 50
 - 6.3.2 Protection of two cylinders not in contact 51
 - 6.3.3 Protection of a cylinder close to a stationary component 51
 - 6.3.4 Protection of a cylinder in contact with a stationary flat surface 52
 - 6.3.5 Protection of a cylinder in contact with a belt or a flat moving component 52

Appendix

- Appendix A Quick reference: Hazards 53
- Appendix B Annex B of ISO 14120:2002 59
- Appendix C Figure 1 of ISO 12100-2:2003 61
- Appendix D Examples of use of Tables 5-1 and 5-2 63

References 67

Bibliography 69

List of figures

Figure I	Risk reduction hierarchy [1]	9
Figure 1	Possible location of the danger zone	11
Figure 2-1	Risk reduction management [1]	19
Figure 2-2	Elements of risk	21
Figure 2-3	Risk graph	21
Figure 3-1	Fixed enclosing guard	28
Figure 3-2	Fixed distance guard	29
Figure 3-3	Fixed nip guard	29
Figure 4-1	Minimum gap to avoid crushing hazards	31
Figure 4-2	Possible modifications to a worm drive to protect only the hand	32
Figure 4-3	Minimum gap between the robot and the guard (safety zone provided in the safety enclosure)	32
Figure 4-4	Protection by reducing the forces and energy levels of moving components	34
Figure 5-1	Possible location of the danger zone	35
Figure 5-2	Access by reaching upwards	35
Figure 5-3	Access by reaching over a guard	36
Figure 5-4	Access by reaching through a guard	38
Figure 5-5	Shape of openings in guards (slot, square, or circle)	38
Figure 5-6	Safety scale	40
Figure 5-7	Irregular-shaped opening	40
Figure 5-8	Tunnel guard	40
Figure 5-9	Safeguarding by distance for a worm drive	41
Figure 5-10	Plastic crusher equipped with chicanes	41
Figure 5-11	Access from below a guard	41
Figure 6-1	In-running nip created by two cylinders in contact	45
Figure 6-2	In-running nips created by two cylinders not in contact (identical, with a different coating or a different diameter)	45
Figure 6-3	In-running nip created by a cylinder close to a stationary object	46
Figure 6-4	In-running nip created by the winding of material	46
Figure 6-5	Use of a retractable cylinder at the juncture between two conveyor belts	46
Figure 6-6	Perimeter of the drawing-in zone	47
Figure 6-7	In-running nip created by two cylinders in contact	47
Figure 6-8	In-running nip created by a cylinder in contact with a belt	48
Figure 6-9	In-running nip created by two cylinders in contact with a sheet of material	48
Figure 6-10	In-running nip created by two cylinders not in contact	49
Figure 6-11	Nip guard – Spacing and geometry	49
Figure 6-12	Nip guard for two cylinders in contact	50
Figure 6-13	Prevention during the design step for two cylinders not in contact	51
Figure 6-14	Prevention during the design step for one cylinder and one stationary component	51

Figure 6-15	Nip guards for a cylinder in contact with a stationary flat surface	52
Figure 6-16	Nip guards for a cylinder in contact with a belt	52
Figure B	Chart for the selection of guards according to the number and location of hazards	59
Figure C	Guidelines to help make the choice of safeguards against hazards generated by moving parts	61
Figure D-1	Fixed distance guard – Example 1	64
Figure D-2	Fixed distance guard – Example 2	65

List of tables

Tableau 1	Current laws and regulations	12
Tableau 4	Maximum values of force and energy	34
Tableau 5-1	High risk – Reaching over a guard	37
Tableau 5-2	Low risk – Reaching over a guard	37
Tableau 5-3	Relationship between maximum opening and safety distance “sd”	39
Tableau 5-4	Reaching under a guard (lower limbs only)	42

Introduction

When machine-related mechanical hazards (refer to the quick reference in Appendix A) cannot be eliminated through inherently safe design, they must then be reduced to an acceptable level, or the hazards that cause them must be isolated from the workers by guards that allow the minimum safety distances to be respected.

Most of the risks related to mechanical hazards can be reduced to acceptable forces or energy levels (see Table 4 in point 4.2) by applying a risk reduction strategy (see Figure 1). If this is impossible, the hazards must be isolated from people by guards that maintain a safety distance between the danger zone and the people, with the main result being to reduce access to the danger zone.

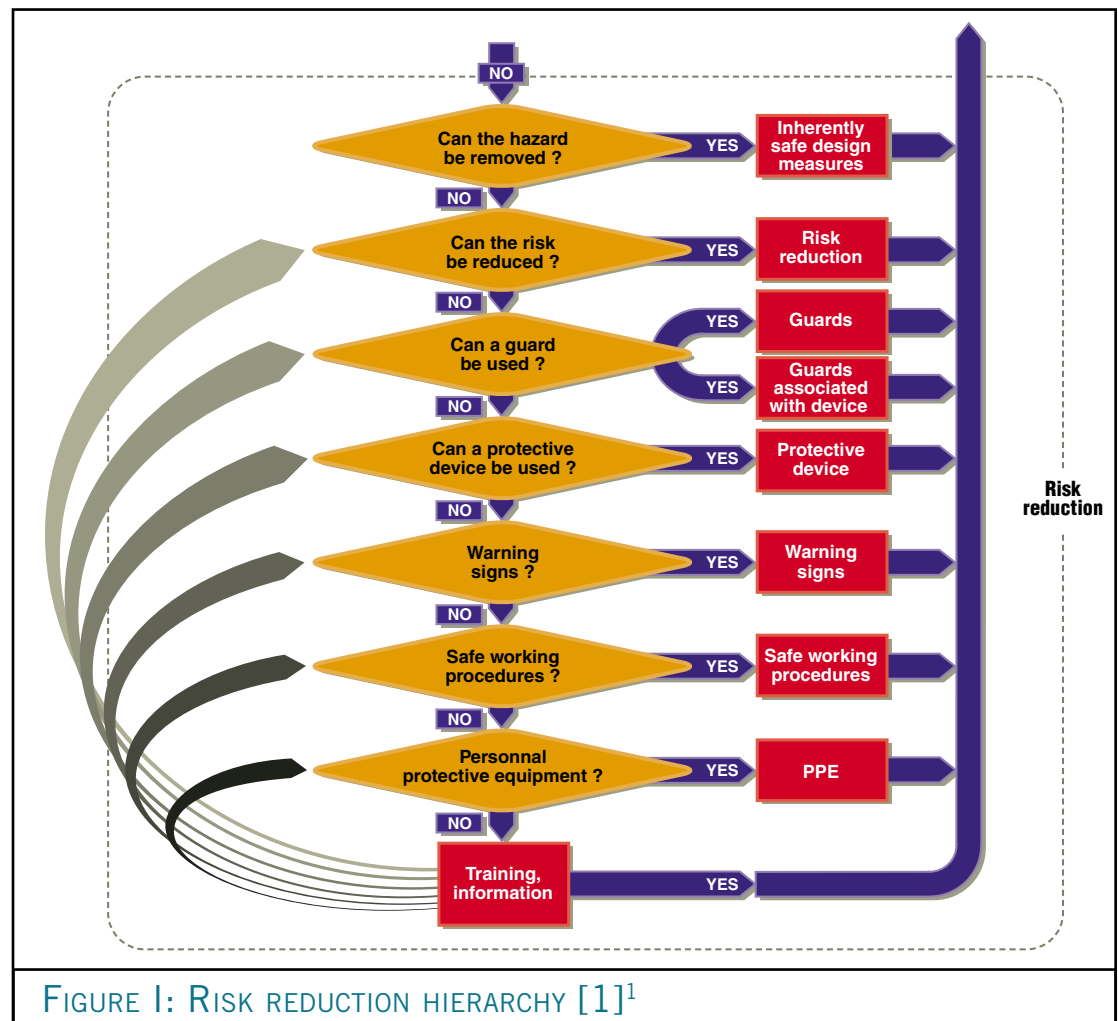

FIGURE 1: RISK REDUCTION HIERARCHY [1]¹

The main factors to be taken into consideration so that guards are effective are:

- ▶ the accessibility to the danger zone by the different parts of the human body;
- ▶ the anthropometric dimensions of the different parts of the human body;
- ▶ the dimensions of the danger zones as well as their position in space and in relation to the ground or the working platform.

1. In this guide, references are in brackets [] and the list of references is at the end of the document.

Section I

General information

The list of laws and regulations applying to machine safety situates mechanical hazard prevention in a legislative context.

The purpose of the series of definitions based on standards is to make the concepts discussed in this guide easier to understand.

1.1 Plan of the guide

The general risk-reduction principles are briefly explained in Section 2, the protection principles involving guards are discussed in Section 3, and crushing hazards are presented in Section 4. The different situations in which the distance protection principle applies (see Figure 1) are then discussed.

- ▶ Is the danger zone, which is located above, accessible from below? (See point 5.1.)
- ▶ Is the danger zone accessible from above the guard? (See point 5.2.)
- ▶ Is the danger zone accessible through one of the openings in the guard? (See point 5.3.)
- ▶ Is the danger zone accessible from below the guard? (See point 5.4.)

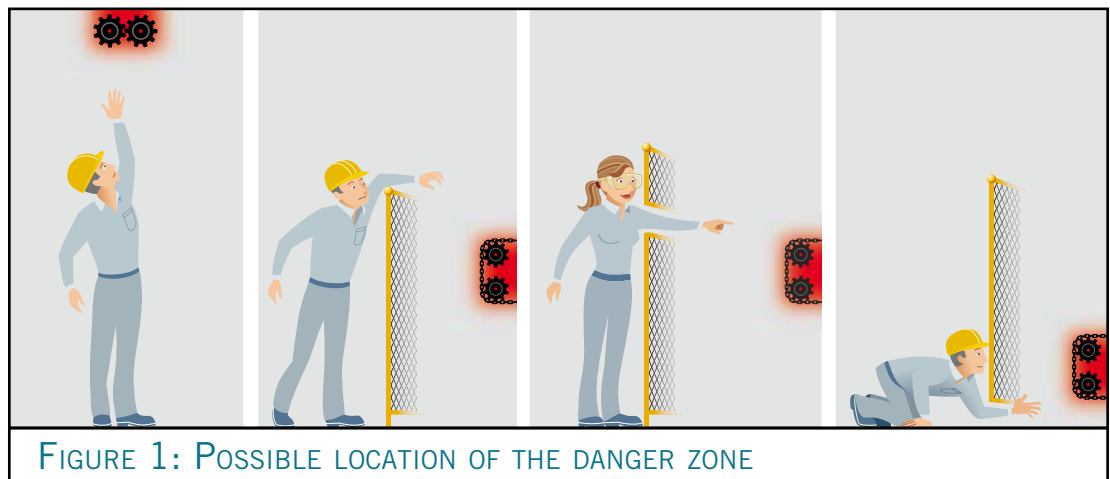

Finally, protection against some specific hazards, such as risks of entanglement or being drawn into in-running nips, is discussed in Section 6.

1.2 Current laws and regulations

In Québec, section 63 of the *Act respecting occupational health and safety* (R.S.Q., c. S-2.1) states that: “No person may manufacture, supply, sell, lease, distribute or install any product, process, equipment, material, contaminant or dangerous substance unless it is safe and in conformity with the standards prescribed by regulation.”

In addition, machines can compromise people’s safety. On this subject, the *Engineers Act* (R.S.Q., c. I-9) mainly indicates that “industrial work or equipment involving public or employee safety” is included in the engineer’s professional practice.

The table below presents a list of the main sections that apply to machines in the different legislation.

TABLE 1: CURRENT LAWS AND REGULATIONS

Legislation	Sections applicable to machines, with title
<i>Act respecting occupational health and safety</i> (R.S.Q., c. S-2.1)	2. Object
	49. Worker’s obligations
	51. Employer’s obligations
	63. THE SUPPLIER - Dangerous substance
	190. Order
<i>Regulation respecting occupational health and safety</i> (c. S-2.1, r. 19.01)	DIVISION XXI - MACHINES
	§1. Protectors and protective devices
	172. (danger zone)
	173. Applicable provisions
	174. Permanent protector
	175. Interlocking protector
	176. Interlocked protector
	177. An automatic closing protector
	178. Adjustable protector
	179. Sensor device
	180. Two-hand control
	181. Multiple two-hand control
	182. Controlling the danger zone
	183. Equivalent safety precautions
	184. Installation
	185. Making secure
	186. Adjustment, repair, unjamming, maintenance and apprenticeship
	187. Characteristics of a protector
188. Spare part	

	§ 2. Control devices or switches
	189. Control devices and switches
	190. Start and stop switches
	191. Warning device
	192. Emergency stop
	193. Groups of machines
	§ 4. Grinding machines and abrasive materials
	197. Grinding machines
	§ 5. Grinders
	201. Protectors and protective devices
	202. Housing
	203. Spark shield
	204. Gap adjustment
	205. Transparent screen
	§ 6. General purpose machines for wood working and saws
	207. Bandsaw
	208. Circular saw
	DIVISION XXIII - HANDLING AND TRANSPORTING MATERIAL
	§ 3. Conveyors
	266. Transmission devices
	267. Protection from falling objects
	270. Emergency stop
	271. Bucket conveyors
	DIVISION XXVIII - OTHER HIGH RISK TASKS
	323. Tasks involving maintenance or repairs
<i>Regulation respecting occupational health and safety in mines (c. S-2.1, r. 19.1)</i>	373. (Guards and protective devices for conveyors)
<i>Safety Code for the construction industry (c. S-2.1, r. 6)</i>	§ 3.10. Construction equipment
	3.10.13. Safety and protective devices
	3.10.14. Abrasive wheels
	3.10.15. Saws
	3.16.9. Conveyors
	§ 8.7. Traffic
	8.7.2. (Protection of ladders or stairs)
<i>Engineers Act (R.S.Q., c. I-9)</i>	DIVISION II - PRACTICE OF THE ENGINEERING PROFESSION

1.3 Definitions of the terms used in this guide

These definitions are based on the following standards: ISO 13849-1:1999 [2], ISO 14121:1999 [3], ISO 12100-1:2003 [4], EN 1010-1:2004 [5] and ISO 11161:2007 [6].

▶ **Risk analysis**
Combination of the determination of the limits of the machine, hazard determination (also called identification), and risk estimation.

▶ **In-running nip or convergence zones**
Danger points at the rollers, reels, cylinders or drums whose movement creates a narrowing and are the cause of a risk of parts of the body or the whole body being drawn in between:

- ▶ two rollers, power-operated or not, turning in opposite directions;
- ▶ a turning roller and a stationary component of the machine;
- ▶ rollers turning in the same direction or conveyor belts moving in the same direction and with different velocities or surfaces (friction);
- ▶ one roller and transmission belts, a conveyor, and potentially, a sheet of material [...].

There are also convergence zones on the non-powered rollers (guiding rollers) driven by the sheet of material. The risk level can be related to different factors such as the type and strength of the material, the winding angle, and the velocity of the sheet of material and the moment of inertia.

▶ **Risk assessment**
Overall risk analysis and risk evaluation process.

▶ **Protective device**
Means of protection other than a guard.

▶ **Harm**
Physical injury or damage to health.

▶ **Risk estimation**
Definition of the probable severity of harm and the probability of this harm.

▶ **Risk evaluation**
Action intended to establish, based on the risk analysis, whether the risk reduction objectives have been met.

▶ **Hazardous event**
Event likely to cause harm.

▶ **Reliability (of a machine)**
Capacity of a machine or its components or equipment to perform a required function without failure, under given conditions and for a specific period of time.

▶ **Safety function**
Function of a machine whose failure can cause an immediate increase in the risk or risks.

▶ **Reasonably foreseeable misuse**

Use of a machine in a manner that does not correspond to the designer's intentions, but that can result from easily foreseeable human behaviour.

▶ **Unexpected or unintended start-up**

Any start-up that, due to its unexpected nature, creates a hazard. For example, such a start-up can be caused by:

- ▶ a start command resulting from a failure of the control system or an outside influence on this system;
- ▶ a start command resulting from an inappropriate human action on a start-up control or on another component of the machine, as for example, on a sensor or a power control element;
- ▶ the reestablishment of the power supply after an interruption;
- ▶ outside or inside influences (for example, gravity, wind, auto-ignition in internal combustion motors) on the machine's components.

Note. – Machine start-up during normal sequence of an automatic cycle is not unintended, but can be considered to be unexpected from the worker's standpoint. In this case, accident prevention is based on the application of protective measures (see ISO 12100-2:2003, section 5 [7]).

▶ **Safeguard**

Guard or protective device.

▶ **Hazard²**

Possible source of harm.

Note 1. – The expression hazard and the term risk (in the sense of hazard) may be qualified in order to identify the origin (for example, mechanical, electrical) or the nature of the possible risk (for example, electric shock, cut, intoxication, fire).

Note 2. – The hazard considered in this definition:

- *permanently present during the intended use of the machine (for example, movement of hazardous moving components, electric arc during a welding phase, awkward posture, noise emission, high temperature); or*
- *might appear unexpectedly (for example, explosion, crushing hazard resulting from unintended or unexpected start-up, projection resulting from breakage, sudden acceleration or deceleration).*

▶ **Inherently safe design measures**

Protective measure which either eliminates hazards or reduces the risks associated with hazards by changing the design or operating characteristics of the machine without the use of guards or protective devices.

Note – ISO 12100-2:2003, section 4, deals with risk reduction by means of inherently safe design measures.

2. In the Act respecting occupational health and safety (AOHS) [8], the term "risk" is understood as a "hazard".

▶ **Guard (Protector)³**

Physical barrier designed as a component of the machine and that provides a protective function.

Note 1. – A guard can achieve its effect:

- *alone. It is then effective only when it is held in place securely, if it is a fixed guard;*
- *associated with an interlocking device. In this case, protection is ensured, regardless of the position of the guard.*

Note 2. – Depending on its purpose, a guard can be called a housing, shield, cover, screen, door, cabinet.

Note 3. – See ISO 12100-2:2003, section 5.3.2, and ISO 14120:2002 on the different types of guards and the requirements that apply to them.

▶ **Fixed guard⁴ (equivalent to the “permanent protector” defined in the ROHS)**

Guard secured in such a way (for example, by screws, nuts or welding) that it can only be opened or removed with tools or by eliminating the means of fixation.

▶ **Movable guard**

Guard that can be opened without using tools.

▶ **Interlocking guard⁵ (equivalent to the “interlocking protector” defined in the ROHS)**

Guard associated with an interlocking device in order to ensure, with the machine's control system, that:

- ▶ the machine's hazardous functions that are protected by the guard cannot operate as long as the guard remains open;
- ▶ a stop command is given if the guard is opened while the machine's hazardous functions are operating;
- ▶ the machine's hazardous functions that are protected by the guard can operate when the guard is closed, but closing the guard does not by itself initiate their operation.

Note. – ISO 14119:1998 [10] contains detailed information on this subject.

3. See section 172 of the Regulation respecting occupational health and safety (ROHS) [9].

4. See section 174 of the ROHS [9].

5. See section 175 of the ROHS [9].

▶ **Interlocking guard with guard locking⁶ (equivalent to the “interlocked protector” defined in the ROHS)**

Guard associated with an interlocking device and a guard locking device in order to ensure, with the machine’s control system, that:

- ▶ the machine’s hazardous functions that are protected by the guard cannot operate until the guard is closed and locked;
- ▶ the guard remains closed and locked until the risk attributable to the machine’s hazardous functions that are protected by the guard has passed;
- ▶ when the guard is closed and locked, the hazardous functions that are protected by the guard can operate. Closing and locking of the guard do not themselves initiate the machine’s hazardous functions.

Note. – ISO 14119:1998 contains detailed information on this subject.

▶ **Safeguarding**

Prevention measures using safeguards to protect the workers from the hazards that cannot be reasonably eliminated or risks that cannot be sufficiently reduced by applying inherently safe design measures.

▶ **Risk**

Combination of the probability of harm and the severity of this harm.

▶ **Hazardous situation**

Situation in which a worker is exposed to at least one hazard. Exposure to this or these hazards can lead to harm, immediately or over the longer term.

▶ **Integrated manufacturing system**

Group of machines operating together in a coordinated way, connected by a material handling system and interconnected by actuators (namely controls), for the purpose of manufacturing, processing, moving or conditioning different components or assemblies.

▶ **Intended use of a machine**

Use of a machine according to the information in the operating instructions.

▶ **Danger zone⁷**

Any space, inside or around a machine, in which a worker can be exposed to a hazard.

6. See section 176 of the ROHS [9].

7. See section 172 of the ROHS [9].

Section 2 General risk-management principles

Risk management involves two major steps (see Figure 2-1): risk assessment [3] and risk reduction [4, 7].

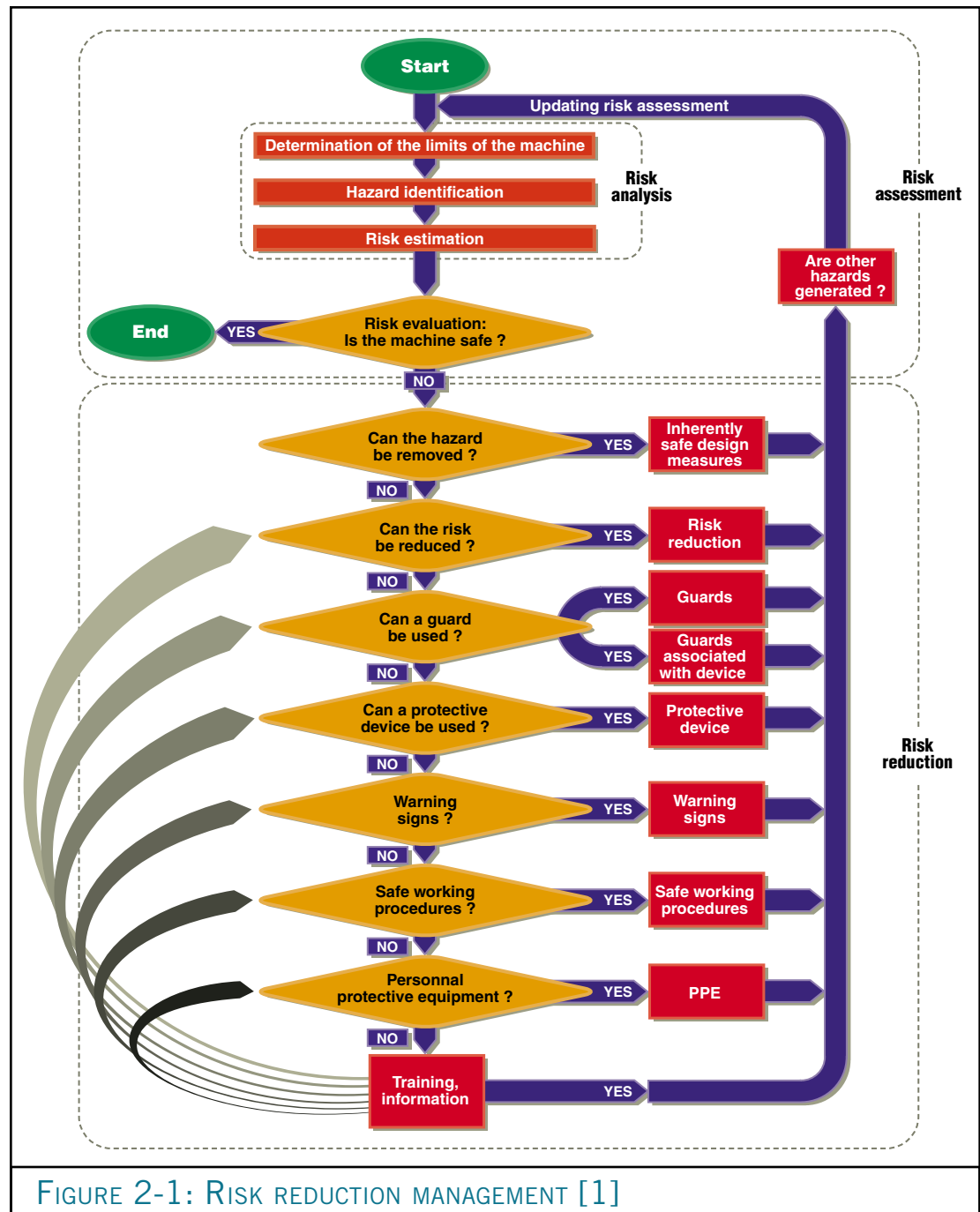

FIGURE 2-1: RISK REDUCTION MANAGEMENT [1]

2.1 Risk assessment

In general, any improvement to a machine's safety begins with a risk assessment. This operation includes a risk analysis, followed by a risk evaluation.

2.1.1 Risk analysis

A risk analysis has three steps:

- ▶ determining the limits of the machine;
- ▶ determining (identifying) the hazards;
- ▶ estimating the risks.

2.1.1.1 Determining the limits of the machine

The very first step in the risk management process involves establishing the limits of the risk assessment. At the end of this step, you must be able to describe the conditions in which the machine will be used: who will use the machine, for how long, with what materials, etc. The machine's life cycle (design, installation, use, unjamming, maintenance and disposal), foreseeable uses, and the users' expected level of experience are also established.

Only once these conditions have been determined can hazard identification and risk estimation begin.

2.1.1.2 Identifying the hazards

Hazards are the cause of all hazardous situations. When exposed to a hazard, a worker is in a hazardous situation, and the occurrence of a hazardous event leads to an accident that can result in harm.

Hazard identification is one of the most important steps in the risk management process. The list of hazards must be carefully established. The CSST's information kit [1] can be useful for this.

A list of all the energy sources or all the man-machine interfaces that can affect the health and safety of exposed workers must be carefully established, whether they are moving elements (mechanical hazard), electrified components (electrical hazard), machine components that are too hot or too cold (thermal hazard), noise, vibration, visible (laser) or invisible radiation (electromagnetic), hazardous materials or awkward postures (ergonomic hazard). These hazards are then linked to the hazardous situations to which the workers are exposed.

2.1.1.3 Risk estimation

Risk estimation consists of comparing the different hazardous situations identified. This relative comparison establishes an action priority, for example.

Risk is defined as the combination of the severity of the harm (**S**) and the probability of occurrence of this harm (see Figure 2-2). The probability of the harm occurring [3] can be divided into three parts:

1. the frequency and duration of exposure to the hazard (**F**);
2. the probability of a hazardous event occurring (**O**);
3. the possibility of avoiding or reducing the harm (**A**).

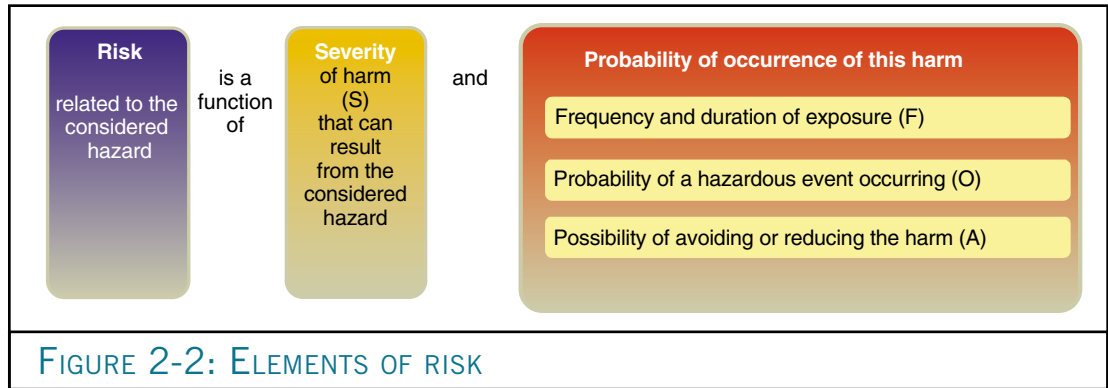

To make this estimation easier, a risk index can be defined for each hazardous situation. Document ED 807 from the INRS [11] proposes a range of values to be associated with the components of the risk. Once the ranges of values have been defined, risk estimation tools can be used. These can be graphical tools [1] (see Figure 2-3), matrix tools, etc.

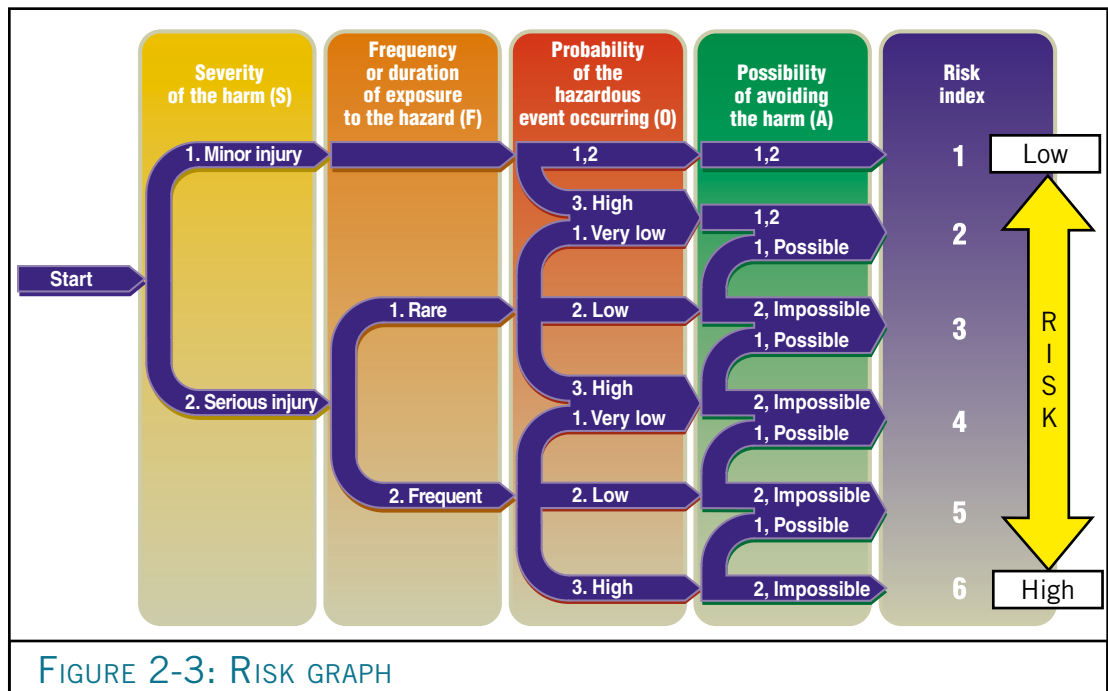

In practice, it is important to establish objective limits for factors **S**, **F**, **O** and **A** beforehand by consulting references. The following pages contain examples showing the use of the risk graph in Figure 2-3.

▶ **Severity of the harm (S)**

The severity of the harm can be estimated by taking into account the severity of the injuries or adverse health effects. The proposed choices are:

- S1** Minor injury (normally reversible). For example: scrape, laceration, bruise, slight injury, etc.;
- S2** Serious injury (normally irreversible, including death). For example: limb broken or torn out, serious injury with stitches, etc.

▶ **Frequency or duration of exposure to the hazard (F)**

The exposure can be estimated by taking into consideration:

- the need to access the danger zone (for example, for normal operation, maintenance or repairs);
- the reason for access (for example, manual feeding of materials);
- the time spent in the danger zone;
- the number of people that must access it;
- the frequency of access.

The proposed choices are:

- F1** From rare to rather frequent, or short exposure;
- F2** From frequent to continuous, or long exposure.

▶ **Probability of the hazardous event occurring (O)**

The probability of the hazardous event occurring can be estimated by considering:

- reliability data and other statistical data;
- the accident history;
- the history of adverse health effects;
- a comparison of the risks with those of a similar machine (if certain conditions are met).

The proposed choices are:

- O1** Very low (from very low to low). Stable, proven technology recognized for safety applications, material strength;
- O2** Low (from low to average). Hazardous event related to a technical failure or event caused by the action of a qualified, experienced, trained worker with an awareness of the high risk, etc.;
- O3** High (from average to high). Hazardous event caused by the action of a worker lacking experience or specific training.

► Possibility of avoiding the harm (A)

The possibility of avoidance allows the harm to be prevented or reduced in relation to:

- the workers using the machine;
- the rapidity of appearance of the hazardous event;
- the awareness of the hazard's existence;
- the possibility of the worker avoiding or limiting the harm (for example, action, reflex, agility, possibility of escape).

The proposed choices are:

A1 Possible under certain conditions;

A2 Impossible or rarely possible.

By combining the results obtained for the four parameters, the risk index is defined by using the risk graph (see Figure 2-3), which allows six increasing risk indexes to be defined (varying from 1 to 6).

The risk estimation tools, such as the tool presented in Figure 2-3, are often used at the time of risk evaluation. Reference [3] provides more information on the conditions that help determine whether the safety objective has been met.

For example, an air compressor is located in the work area; two in-running nips exist between the belt and the pulleys:

- Severity of the harm: **S2**, high (loss of at least one finger);
- Duration of exposure: **F2**, because the compressor is in the work area where the workers move around;
- Occurrence: **O3**, because the worker is not trained in using the targeted machine;
- Possibility of avoidance: **A2**, because the finger cannot be removed from the in-running nip once it has been caught, if the compressor starts automatically;
- Calculated risk index: 6.

Once all the hazardous situations have been estimated, the different risk indexes must be compared to ensure consistency in the entire analysis.

2.1.2 Risk evaluation

The last step in the risk assessment process consists of making a judgement about the estimated risk level. At this step, it is determined whether the risk is tolerable or not.

When the risk is considered intolerable (high risk index, as in the case of the compressor in the previous example), risk reduction measures must be selected and implemented. In order to ensure that the chosen solutions fulfill the risk reduction objectives without creating new hazardous situations, the risk assessment procedure must be repeated once the solutions have been applied.

2.2 Risk reduction

Once the risk assessment step has been completed, if the evaluation prescribes a reduction of the risk (which is considered intolerable), means to be applied to achieve the risk reduction objectives must be selected. Figure 2-1 illustrates the hierarchy in the risk reduction measures.

2.2.1 Hazard elimination and risk reduction

As stated in section 2 of Québec's Act respecting occupational health and safety [8]⁸, eliminating the hazard is the first objective. The risk must be eliminated in order to make the situation safe: this is called inherently safe design.

According to section 4.1 of ISO 12100-2:2003 [7]: “Inherently safe design measures are the first and most important step in the risk reduction process [...]. Inherently safe design measures are achieved by avoiding hazards or reducing risks by a suitable choice of design features of the machine itself [...].”

It is therefore at the machine design step that the worker's safety is ensured. The designer tries to improve the machine's characteristics: creating a gap between the moving components in order to eliminate the trapping zones, eliminating sharp edges, limiting the drawing-in forces or limiting the energy levels (mass, velocity, acceleration) of the moving components.

2.2.2 Guards and protective devices

Guards, whether they are fixed or interlocking guards or interlocking guards with guard locking⁹, rank just below inherently safe design in terms of effectiveness in the hierarchy of risk reduction measures. Protective devices and electro-sensitive protective devices come next, such as safety light curtains, pressure mats, surface detectors or two-hand controls. The document, *Amélioration de la sécurité des machines par l'utilisation des dispositifs de protection*¹⁰, presents an introduction to the use of these devices.

2.2.2.1 Fixed guards and guards with interlocking devices

One of the best ways of reducing exposure to a hazard is to prevent access to it by installing a guard. Ideally, it is “fixed” and a tool must be used to remove it. However, the guard may have to be opened for periodic access to the danger zone, for example, for production, unjamming or maintenance purposes.

These “movable” interlocking guards or interlocking guards with guard locking must send a stopping signal to the machine as soon as they are opened. If the machine stopping time is short enough for the hazard to stop before the worker can reach it, an interlocking guard is used. However, if the hazard stopping time is longer, an interlocking guard with guard locking is used which, in addition to performing the functions of the interlocking guard, locks the guard in the closed position until the hazard has completely passed.

8. “The object of this Act is the elimination, at the source, of dangers to the health, safety and physical well-being of workers.” AOHS, section 2.

9. In the sense of the definitions appearing in this guide.

10. *Amélioration de la sécurité des machines par l'utilisation des dispositifs de protection*, IRSST and CSST, accessible at the following address: www.csst.qc.ca.

2.2.2.2 Protective devices

If a guard, either fixed or movable, cannot be considered, one must determine whether a protective device can be used. A protective device¹¹ is defined as any safeguard, other than a guard. For example, it can be an optoelectronic protective device (safety light curtain, surface detector), a validation device, a pressure mat, a two-hand control, etc. These devices are specially designed to reduce the risk associated with a hazardous situation.

2.2.3 Warnings, work methods and personal protective equipment

Procedures, warnings, work methods and personal protective equipment are not considered as being the most effective means. Although essential in situations where no other solution seems to provide satisfactory results, their effects on safety improvement are considered less significant. They are often used with other risk reduction methods.

2.2.4 Training and information

In all cases where the hazard cannot be eliminated, workers must receive training so that they are informed about the nature of the residual risk to which they are exposed and the means that are used for reducing this risk. This training is in addition to the general training that the employer must provide to the workers for the purpose of using the machine¹².

2.2.5 Verification of the final result

In order to ensure that the chosen solutions fulfill the risk reduction objectives without creating new hazardous situations, the risk assessment procedure must be repeated once the solutions have been applied.

11. See section 179 of the ROHS [9], discussing sensor devices.

12. See section 51.9 of the AOHs [8].

Section 3

Guards

Guards rank third in the risk reduction hierarchy, after inherently safe design and risk reduction. Guards must therefore be chosen only if the first two measures cannot reasonably be applied.

A guard must not create additional hazards (cutting, trapping, crushing, etc.) or cause the machine's users to divert the guard from its use. The movable components of a guard must be designed so that their dimensions and their weight facilitate their manipulation.

A guard must be designed by taking into account all the environmental constraints or those operating constraints (possibilities of projections of solid or liquid matter) to which the guard is subjected during the machine's entire service life. The guard must also be designed by taking into consideration, insofar as possible, all the intended uses and reasonably foreseeable incorrect uses of the machine and all the involuntary movements of the workers.

A guard must be designed and built in such a way as to offer good visibility of the process and the machine. This type of design limits the dismantling of the guard while allowing the machine to be checked for proper operation or a malfunction to be detected as soon as it appears. The guard can be made of a transparent, perforated or meshed material (see the permissible dimensions in point 5.3.1). It is suggested that the frame of the guard be painted a bright colour, and the perforated or meshed part a colour darker than the zone to be observed (flat black or charcoal grey).

There are two types of guards

- ▶ Fixed guards:
 - ▶ fixed enclosing guard;
 - ▶ fixed distance guard;
 - ▶ fixed nip guard.
- ▶ Movable guards:
 - ▶ interlocking guard;
 - ▶ interlocking guard with guard locking;
 - ▶ power-operated;
 - ▶ automatic closing



The characteristics and specific features of movable guards are not discussed in this guide.

3.1 Fixed guards

A fixed guard (permanent protector) is a guard that can only be removed with the assistance of a tool or that is set in place permanently, for instance by being welded (ROHS, section 174).

Note. – Depending on its shape, the guard can be called a housing, cover, door, screen or cabinet.

▣ Fixed enclosing guard

Fixed guard that prevents access to the danger zone from all directions (see Figure 3-1) [12].

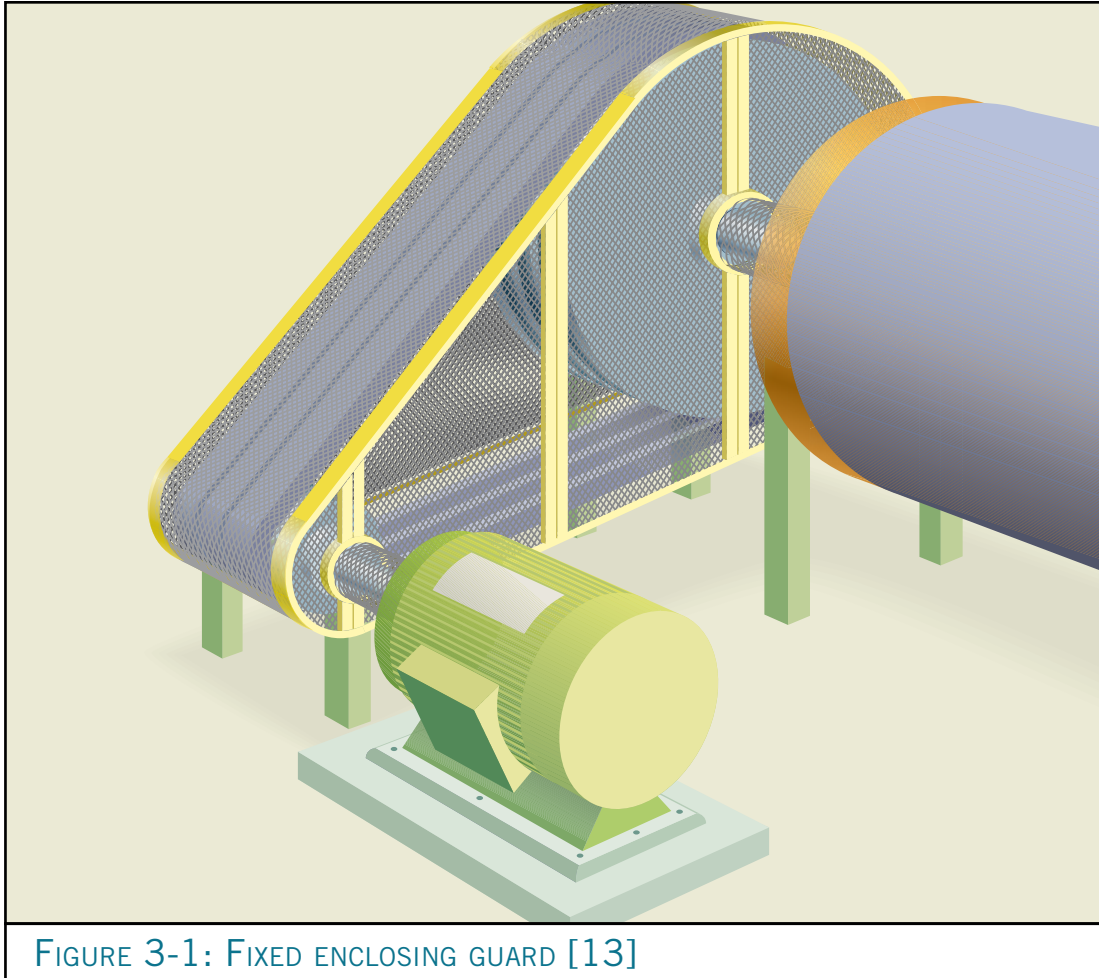

FIGURE 3-1: FIXED ENCLOSING GUARD [13]

▶ **Fixed distance guard**

Fixed guard that does not completely enclose a danger zone, but that prevents or reduces access to it due to its dimensions and its distance from this zone. Example: a peripheral enclosure (see Figure 3-2).

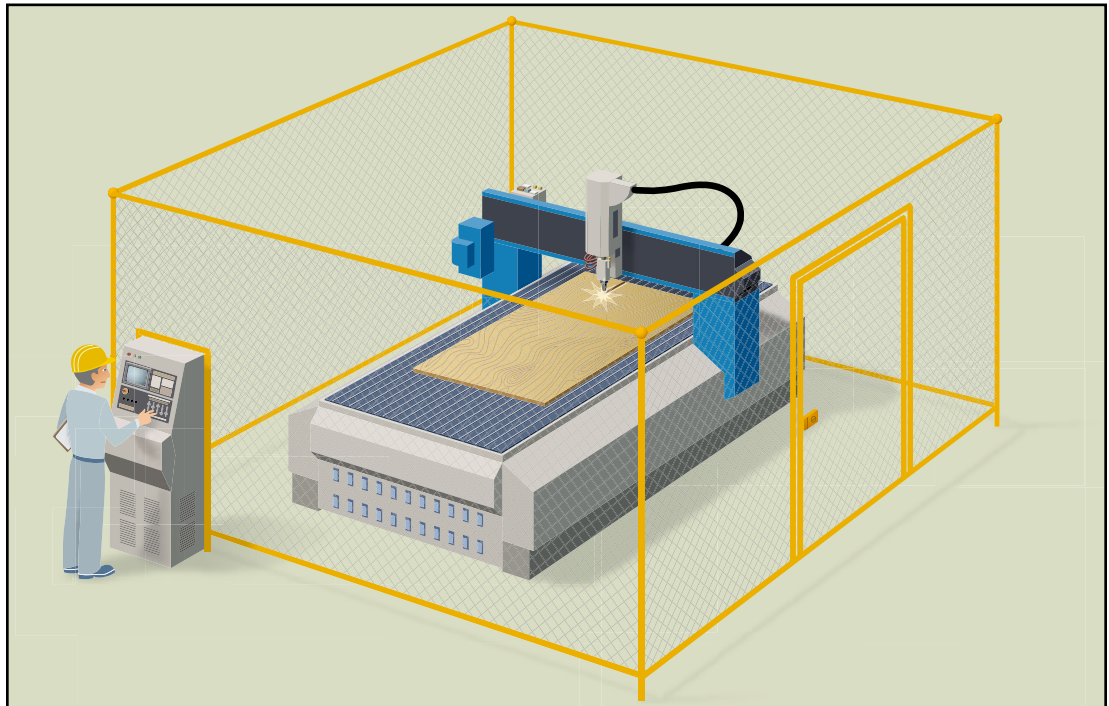

FIGURE 3-2: FIXED DISTANCE GUARD

▶ **Fixed nip guard**

Fixed guard placed near an in-running nip to prevent access to the in-running nip, which creates the danger zone (see Figure 3-3).

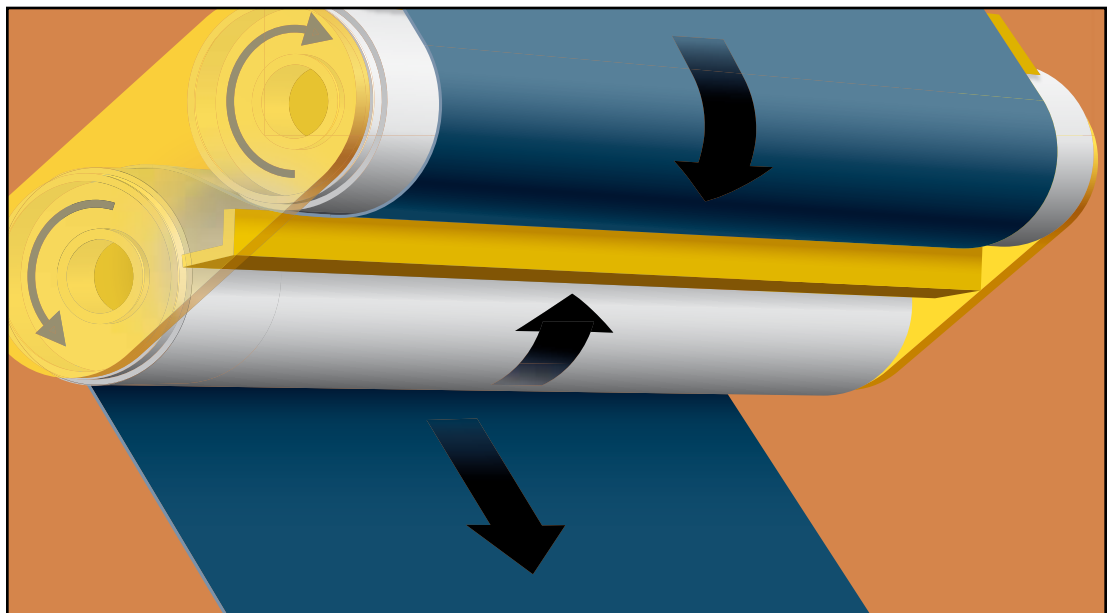

FIGURE 3-3: FIXED NIP GUARD

3.2 Choice of type of guards

The type of guards adapted to the danger zone and to existing hazards can be chosen, for example, by using Appendix B and, as needed, the IRSST guide [14] for guards associated with interlocking devices.

It is recommended [12] that fixed guards be chosen in the following order of priority (see figure in Appendix B):

1. Guards enclosing each danger zone if the number of danger zones is small.
2. Single enclosure guard for all the danger zones if the number or dimensions of these zones are large.
3. Multiple distance guards, if the use of one enclosure guard is impossible and if the number of danger zones is small (each guard protects one part of the machine).
4. Single distance guard (enclosure, for example), if the use of an enclosure guard is impossible and if the number or the dimension of the danger zones is large (see Figure 3-2).

Figure A.1 in Annex A of ISO 14120:2002 [12] or Appendix C of this guide can facilitate the selection of a fixed guard or a movable guard (associated with an interlocking guard or an interlocking guard with a guard locking device).

A combination of different types of guards may be useful, depending on the configuration of the machine (or the integrated manufacturing system) and the production and maintenance requirements (access to one of the danger zones while the machine is in operation).

Once a guard is installed, it is suggested that it be checked to determine whether it fulfills its role well, is properly located, and prevents access to the danger zone without creating new hazards.



When there is the possibility that a worker may remain inside the danger zone (between the guard and the machine), a device preventing the restart of the machine must be provided.¹³

13. This measure does not eliminate the need for applying the provisions of sections 185 and 186 of the ROHS [9].

Section 4

Protection against crushing hazards

Protection of the human body against crushing hazards can be ensured in two ways. A minimum gap can be left between moving components in order to avoid all contact between the moving components and the human body, or the forces or energy levels of the moving components can be reduced in order to limit the consequences of contact with the human body. The first of these two approaches is an inherently safe design measure because the hazard is eliminated, while the second reduces the risk to an acceptable level, namely, it does not create irreversible harm to the human body.

4.1 Protection using a minimum gap between the moving components

The possibility of a crushing hazard must be taken into account in a risk assessment in order to determine the targeted part of the body. In addition, the conditions that increase the risks (wearing thick or bulky clothing, wearing safety shoes with toecaps, etc.) must be taken into account.

The following minimum “d” gaps (see Figure 4-1) must be provided in order to avoid the risk of crushing parts of the human body [15].

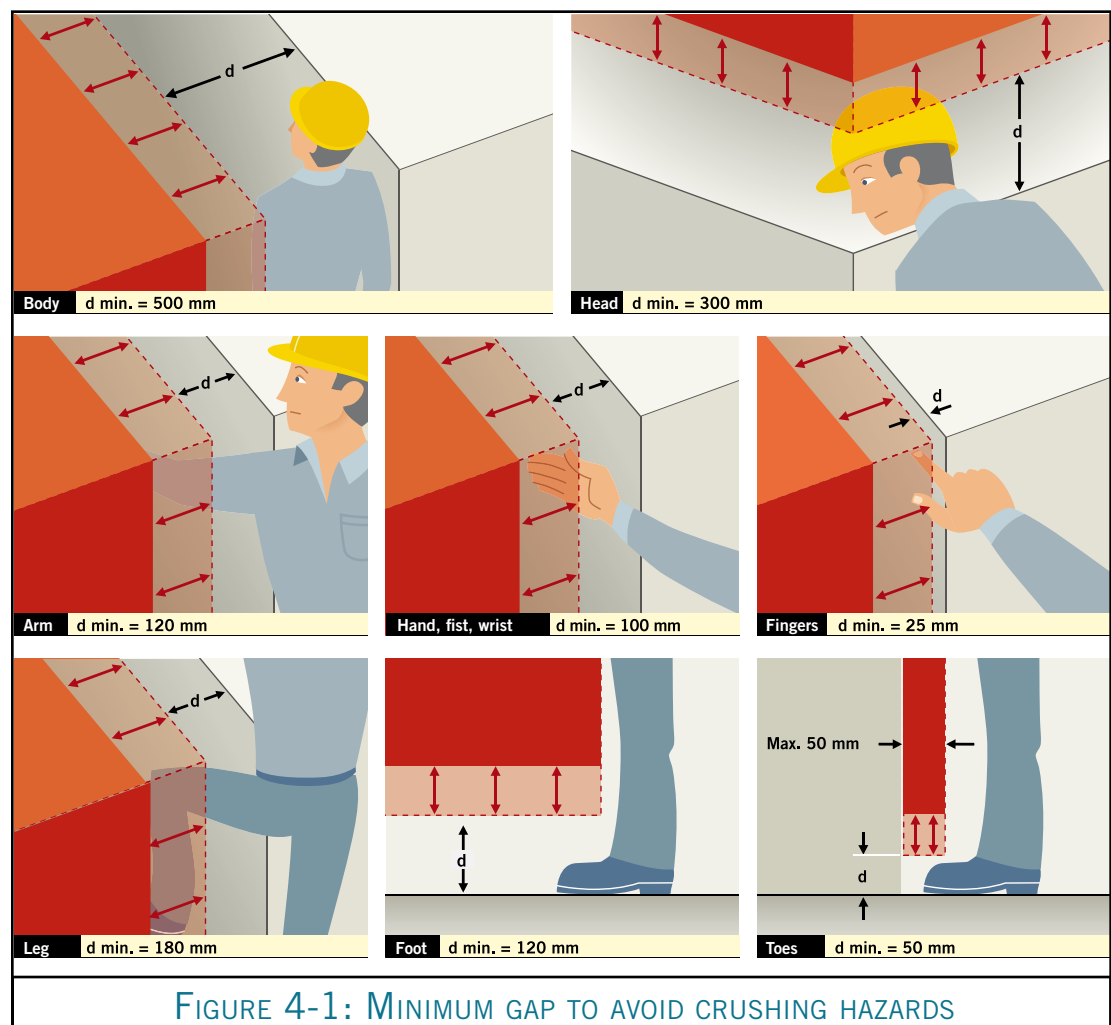
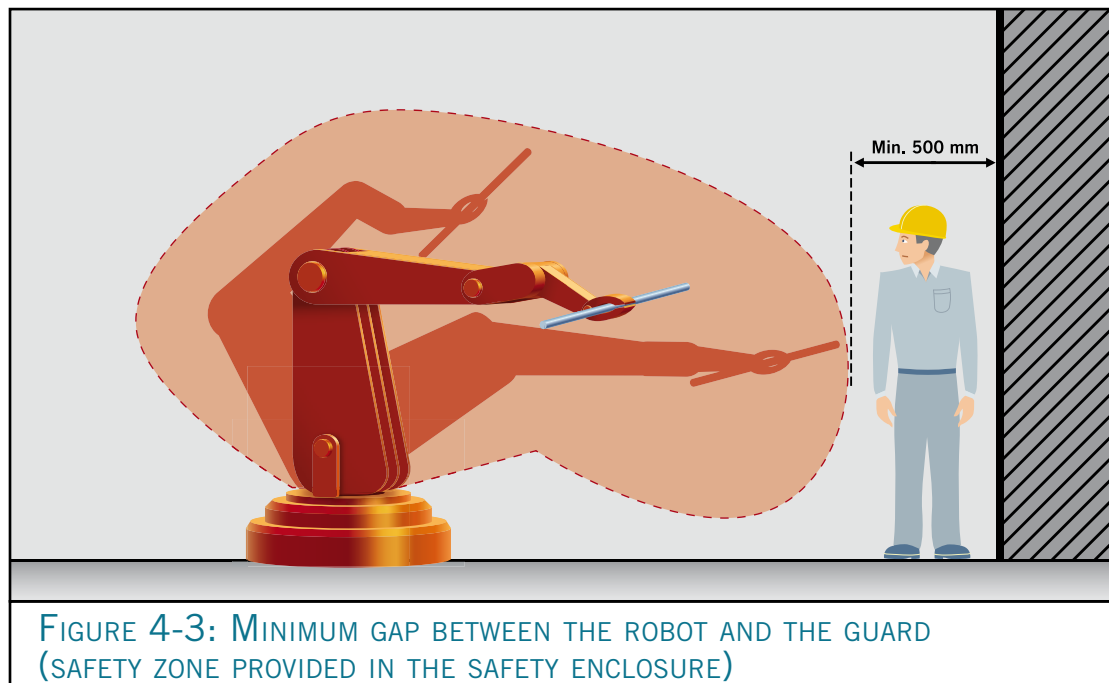
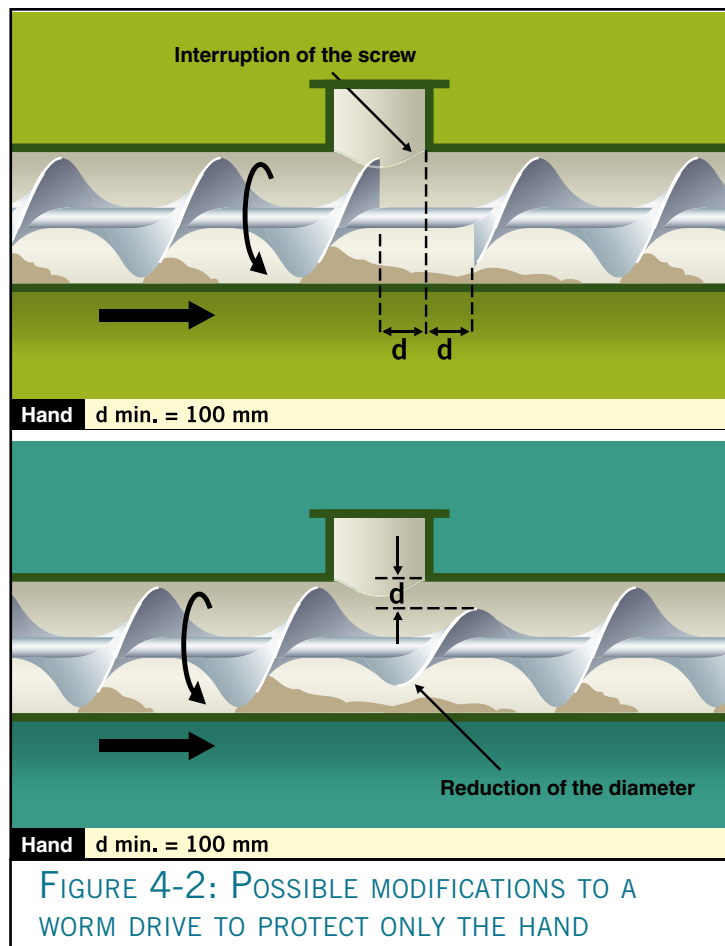

FIGURE 4-1: MINIMUM GAP TO AVOID CRUSHING HAZARDS

When a trapping zone can be accessed by several parts of the body, the largest “d” gap must be chosen (for example, if the trapping zone can be accessed by a hand or arm, the “d” gap must then be be 120 mm).

The application of these dimensions is illustrated in Figure 4-2 for worm drives [16] (hand protection only, when permitted by the nature of the transported product) and Figure 4-3 for robots [17].



4.2 Protection by reducing the forces and energy levels of moving components

In some cases, the forces and energy levels of moving components can be limited in order to eliminate harm to the human body. This principle, which is based on risk reduction, can be applied only if the moving components have characteristics that ensure the required safety function (absence of sharp edges, cutting components, etc.).

In this case, the following factors must be taken into consideration:

- ▶ accessibility of the danger zone;
- ▶ anthropometric dimensions;
- ▶ kinetic energy;
- ▶ pressure on parts of the body;
- ▶ shapes and dimensions of the contact surfaces;
- ▶ reliability of the system (optional);
- ▶ response time of the mechanisms (optional).

If the moving components are not equipped with a device for sensing the presence of a human body (for example, box strapping machine, in Figure 4-4), then the data¹⁴ in the “permanent maximum values” column must be used (see Table 4).

If the moving components are equipped with a protective device (sensing edge) for detecting the human body (see Figure 4-4) and can retract automatically¹⁵ to a safe position, then the data in the “temporary maximum values” column must be used (see Table 4). In this case, the reliability of the control system¹⁶ that returns the moving components to a safe position must be taken into account.

In both cases, one must take into consideration the parts of the body (fingers, hands, etc.) that can accidentally come into contact with the moving component of the machine, and determine whether the forces that come into play are acceptable.

14. The data are from ISO 14120:2002 [12].

15. Some standards prescribe a time of one second before retraction of the moving component.

16. See the *Guide de conception des circuits de sécurité: introduction aux catégories de la norme ISO 13849-1:1999 (version corrigée)* published by the IRSST [14].

TABLE 4: MAXIMUM VALUES OF FORCE AND ENERGY¹⁷

Permanent maximum values	Temporary maximum values
Maximum force on the body* 75 N	Maximum force on the body* 150 N
Maximum kinetic energy of moving component* 4 J	Maximum kinetic energy of moving component* 10 J
Maximum contact pressure** 50 N/cm²	Maximum contact pressure** 50 N/cm²

* In the case of elevators, *The Safety Code for Elevators* (CSA B44-00) [18] states, in section 2.13.3.1.1, that the force necessary to prevent closing of a horizontally sliding car door or gate from rest shall not be more than 135 N. Also, section 2.13.4.2.1 c) mentions that “where a reopening device is not used or has been rendered inoperative [...], the kinetic energy computed for the average closing speed [...] shall not exceed 3.5 J.”

** In the case of box strapping machines, PR EN 415-8:2004 prescribes that the maximum contact pressure must be 25 N/cm² for permanent maximum values.

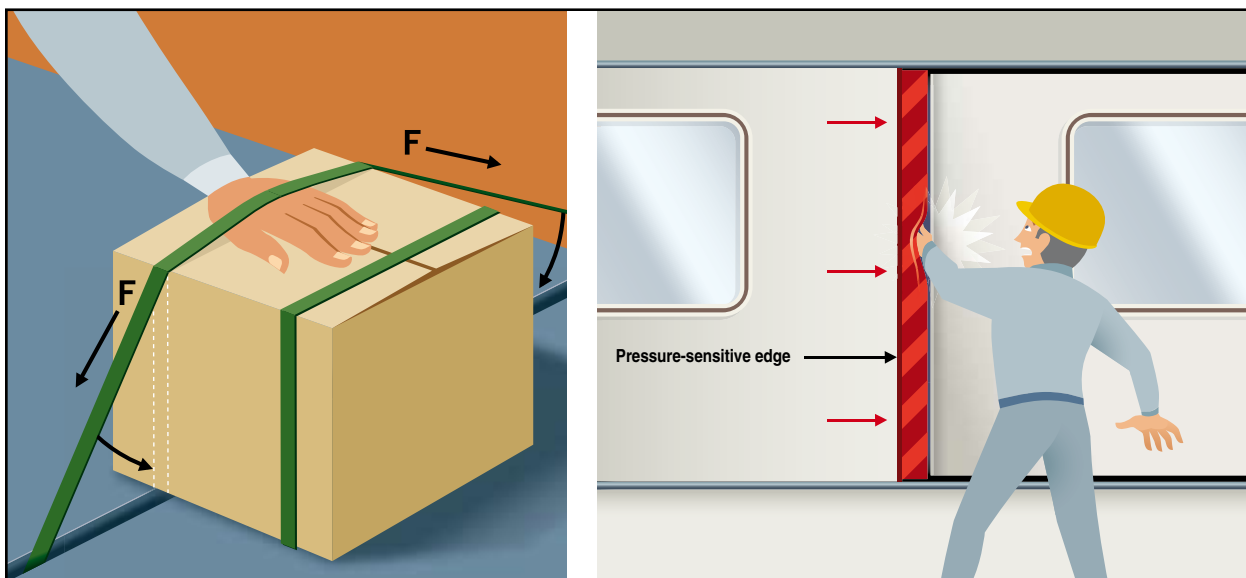

FIGURE 4-4: PROTECTION BY REDUCING THE FORCES AND ENERGY LEVELS OF MOVING COMPONENTS

17. Conversion : 1 N = 0,102 Kgf et 1 N = 0,225 lbf.

Section 5

Safeguarding by distance

Safeguarding by distance involves the use of a fixed or movable guard. Several situations are possible (see Figure 5-1).

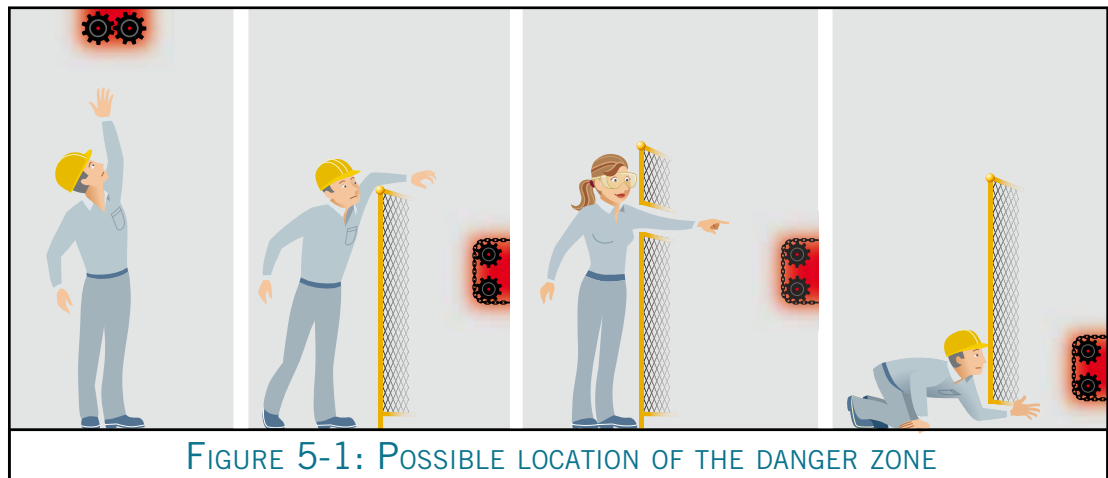

FIGURE 5-1: POSSIBLE LOCATION OF THE DANGER ZONE



In all of the following cases, the established safety distance takes into account the fact that no voluntary movement will be made to reach the danger zone and that no accessory (tool, glove, pole, etc.) or object serving as a step (stepladder, chair, etc.) will be used to reach the danger zone.

5.1 Access by reaching upwards

The safety distance determined between the ground, the catwalk or the permanent working platform and the bottom of the danger zone is a function of the height of the danger zone (see Figure 5-2) and its expected accessibility.

Any danger zone located less than 2.5 m [19] from the ground, catwalk or permanent working platform must be made inaccessible by a guard or by a protective device.

Any danger zone located more than 2.5 m from the ground, catwalk or permanent working platform must be made inaccessible by a guard or by a protective device if its access can be foreseen (for example, a worker doing regular preventive maintenance by using an elevating platform in or near the danger zone). As needed, a complete risk analysis can be done to define the appropriate means of protection.

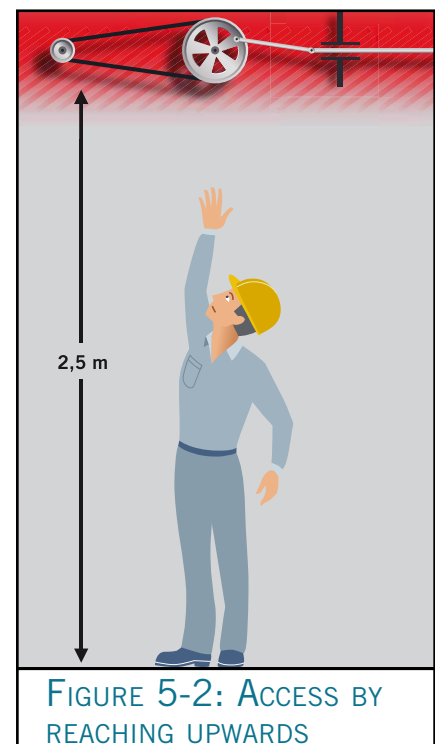

FIGURE 5-2: ACCESS BY REACHING UPWARDS

5.2 Access by reaching over a fixed distance guard

The following symbols are used to designate the critical dimensions relating to access from above the guard (see Figure 5-3):

- ▶ « a » is the height of the danger zone in relation to the ground or working platform;
- ▶ « b » is the height of the guard;
- ▶ « c » is the horizontal distance between the guard and the danger zone.

As a general rule, a distance guard that protects a danger zone must be a minimum of 1800 mm¹⁸ high, and the values “a”¹⁹ and “c” **in bold** in Table 5-1²⁰ must be used.

However, once a risk analysis has been done, all of the values in Table 5-1 can be used as minimum values when the risk is high, or those in Table 5-2 when the risk is low.

No interpolation must be done from the values indicated in these tables. If data “a”, “b” or “c” are between two values, those that provide the greatest safety must be chosen in all cases (see explanatory examples in Appendix D).

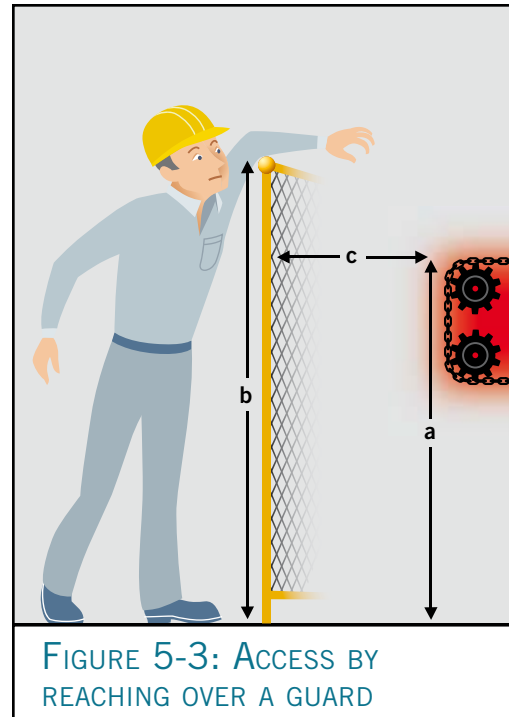

Some “c” values represent a sufficiently large distance to allow a person to get between the distance guard and the danger zone. This possibility must be taken into consideration when the distance guard is chosen. A device preventing the machine from restarting must be provided²¹.

18. CSA Z432-04 [21] mentions in section 10.2.1 that “Barriers shall [...] be positioned so that [...] the top of the barrier is no lower than 1.8 m above adjacent walking surfaces [...].”

19. The most accessible part of the danger zone (the bottom or top of the danger zone) must be taken into consideration.

20. New versions of ISO 13852:1996 [19] and ISO 13853:1998 [22] have been published in the new reference ISO 13857.

21. This measure does not eliminate the need for applying the provisions of sections 185 and 186 of the ROHS [9].

TABLE 5-1: HIGH RISK – REACHING OVER A GUARD [19]

Height of danger zone "a" (mm)	Height of the guard "b"* (mm)							
	1400	1600	1800	2000	2200	2400	2500	2700
Horizontal safety distance to danger zone "c"*** (mm)								
2700	0	0	0	0	0	0	0	0
2600	700	600	600	500	400	300	100	sd
2400	900	800	700	600	400	300	100	sd
2200	1000	900	800	600	400	300	sd	sd
2000	1100	900	800	600	400	sd	sd	sd
1800	1100	900	800	600	sd	sd	sd	sd
1600	1100	900	800	500	sd	sd	sd	sd
1400	1100	900	800	sd	sd	sd	sd	sd
1200	1100	900	700	sd	sd	sd	sd	sd
1000	1000	800	sd	sd	sd	sd	sd	sd
800	900	600	sd	sd	sd	sd	sd	sd
600	800	sd	sd	sd	sd	sd	sd	sd
400	400	sd	sd	sd	sd	sd	sd	sd
200	sd	sd	sd	sd	sd	sd	sd	sd
0	sd	sd	sd	sd	sd	sd	sd	sd

TABLE 5-2: LOW RISK – REACHING OVER A GUARD²² [19]

Height of danger zone "a" (mm)	Height of the guard "b"* (mm)						
	1400	1600	1800	2000	2200	2400	2500
Horizontal safety distance to danger zone "c"*** (mm)							
2500	0	0	0	0	0	0	0
2400	100	100	100	100	100	100	sd
2200	500	500	400	350	250	sd	sd
2000	700	600	500	350	sd	sd	sd
1800	900	900	600	sd	sd	sd	sd
1600	900	900	500	sd	sd	sd	sd
1400	900	800	100	sd	sd	sd	sd
1200	900	500	sd	sd	sd	sd	sd
1000	900	300	sd	sd	sd	sd	sd
800	600	sd	sd	sd	sd	sd	sd
600	sd	sd	sd	sd	sd	sd	sd
400	sd	sd	sd	sd	sd	sd	sd
200	sd	sd	sd	sd	sd	sd	sd
0	sd	sd	sd	sd	sd	sd	sd

* Distance guards less than 1400 mm in height mentioned in ISO 13857:2008 are not taken into consideration because they do not sufficiently limit movement.

** The abbreviation "sd" means safety distance. It is defined in point 5.3.

22. According to ISO/DIS 13857 [20], section 4.1.2, note 1, "Low risks arise from hazards such as friction or abrasion where long term or irreversible damage to the body is not foreseeable."

5.3 Access by reaching through an opening in a guard

The safety distance determined between the danger zone and the guard in the case of access through the guard (see Figure 5-4) is a function of the dimension and shape of the opening.

The following symbols are used:

- ▶ «sd» is the safety distance, namely the distance between the guard and the danger zone;
- ▶ «e» is the smallest dimension of the opening.

5.3.1 Openings in the guard

The guards may include regular-shaped openings (square, round, slot- or groove-shaped) or irregular-shaped openings for feeding the machine or for viewing the danger zone or the process.

Dimension “e” corresponds to the smallest dimension of a rectangular (slot-shaped) opening, to one side of a square-shaped opening, and to the diameter of a circular-shaped opening (see Figure 5-5).

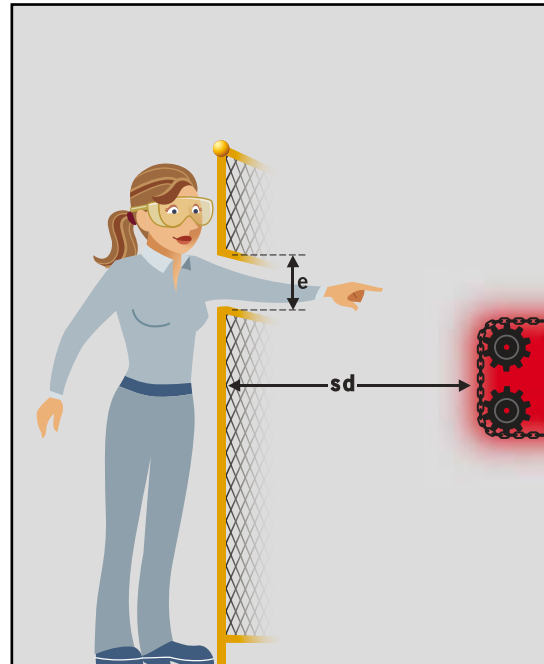

FIGURE 5-4: ACCESS BY REACHING THROUGH A GUARD

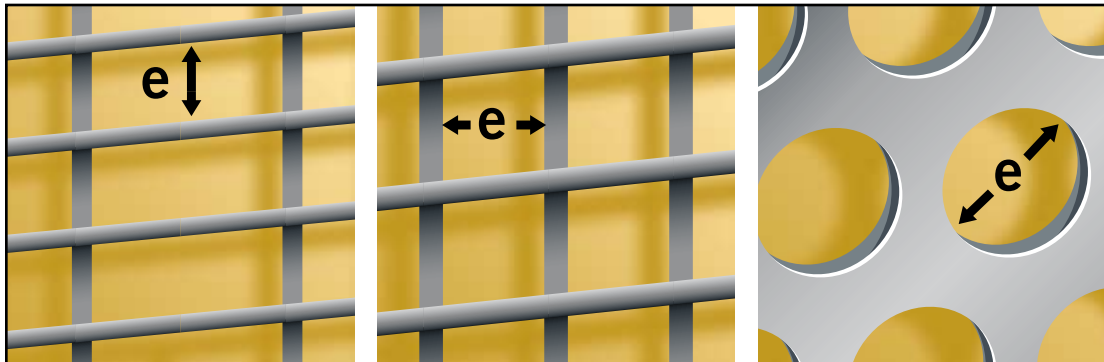

FIGURE 5-5: SHAPE OF OPENINGS IN GUARDS (SLOT, SQUARE, OR CIRCLE)

Table 5-3 is used to determine:

- ▶ the maximum acceptable opening (shape and dimensions) in relation to the chosen safety distance “sd”;
- ▶ the safety distance “sd” as a function of the existing opening (shape and dimensions).

TABLE 5-3: RELATIONSHIP BETWEEN MAXIMUM OPENING AND SAFETY DISTANCE “sd”			
Slot or groove shaped opening (from CSA Z432-04 [21])			
Safety distance “sd” (mm)	Maximum opening (mm)	Opening (mm)	Minimum safety distance “sd” (mm)
Less than 13	S. O.*	From 0 to 6	≥ 13
From 13 to 63,9	6	From 6,1 to 11	≥ 64
From 64 to 88,9	11	From 11,1 to 16	≥ 89
From 89 to 165,9	16	From 16,1 to 32	≥ 166
From 166 to 444,9	32	From 32,1 to 49	≥ 445
From 445 to 914,9	49	From 49,1 to 132**	≥ 915
≥ 915	132**		
Square opening (from CSA Z432-04 [21])			
Safety distance “sd” (mm)	Maximum opening (mm)	Opening (mm)	Minimum safety distance “sd” (mm)
Less than 13	S. O.*	From 0 to 6	≥ 13
From 13 to 47,9	6	From 6,1 to 11	≥ 48
From 48 to 65,9	11	From 11,1 to 16	≥ 66
From 66 to 165,9	16	From 16,1 to 32	≥ 166
From 166 to 444,9	32	From 32,1 to 49	≥ 445
From 445 to 914,9	49	From 49,1 to 132**	≥ 915
≥ 915	132**		
Round opening (from ISO 13852:1996 [19])			
Safety distance “sd” (mm)	Maximum opening (mm)	Opening (mm)	Minimum safety distance “sd” (mm)
Less than 2	0	0 - 4	≥ 2
From 2 to 4,9	4	4,1 < e ≤ 8	≥ 5
From 5 to 19,9	8	8,1 < e ≤ 10	≥ 20
From 20 to 79,9	10	10,1 < e ≤ 12	≥ 80
From 80 to 119,9	12	12,1 < e ≤ 40	≥ 120
From 120 to 849,9	40	40,1 < e ≤ 120***	≥ 850
≥ 850	120***		

* Guards shall not be located less than 13 mm from the hazard.

** The maximum size of a slot- or square-shaped opening is 132 mm.

*** The maximum size of a circular or irregular-shaped opening is 120 mm.

Note. – CSA Z432-04 does not discuss the case of circular or irregular-shaped openings, and hence the reference to ISO 13852:1996. However, note that these two standards contain different limit values.

To verify whether the guard is properly located in relation to the danger zone for “e” openings, it is suggested that a checking gauge (see Figure 5-6) such as a safety scale be used.



FIGURE 5-6: SAFETY SCALE

In the case of an irregular-shaped opening (see Figure 5-7), the safety distance “sd” to be retained is the shortest of the three distances determined from the “e” dimensions deduced from the diameter of the smallest circular opening, one side of the smallest square-shaped opening, and the narrowest width of the slot in which the irregular-shaped opening can be completely inscribed.

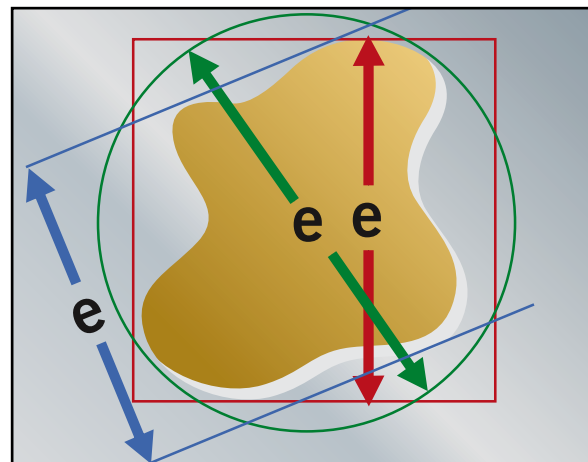

FIGURE 5-7: IRREGULAR-SHAPED OPENING

5.3.2 Tunnel guards

A guard in the form of a tunnel allows the material or the worked part to pass through while preventing the worker from accessing the danger zone (see Figure 5-8). In this case, the safety distance “sd” is the distance of the tunnel from the danger zone “sd1” plus the length of the tunnel “sd2”.

The safety distance “sd” therefore depends on the tunnel’s shape and “e” dimensions. It is appropriate to use the data in Table 5-3 to determine “e” in relation to “sd”, or “sd” in relation to “e”. If openings are made in the guard, the guard must also be located far from the danger zone (see the data in Table 5-3).

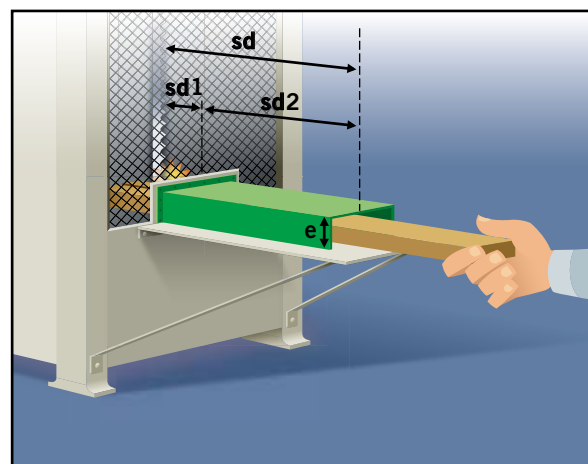

FIGURE 5-8: TUNNEL GUARD

Figure 5-9 illustrates safeguarding by distance for a worm drive [16].

5.3.3 Limiting movement

Free movement of the upper limbs (arms, hands, fingers) can also be limited in space by placing additional elements (support, chicane, deflector, plate, etc.) between the fixed guard and the danger zone (see Figure 5-10). Tables 3 and 6 in ISO 13852:1996 [19] provide examples.

5.4 Access by reaching under a guard

There may be several reasons for not extending the fixed distance guard to the ground: easier cleaning and recovery of parts on the ground, cost, etc. The existence of this gap between the ground and the guard must be taken into consideration in risk assessment in order to determine the safety distance between the danger zone and the guard in the case of access from below the guard (see Figure 5-11).

To limit the need for gaps under the guard, the first consideration could be to eliminate the need for cleaning or parts recovery through the best possible adjustment of the production process or machine. The materials or parts that could still fall or accumulate in the danger zone must automatically be brought towards the guard and outside the protected zone. Inclined panels can be used to direct the falling materials or parts.

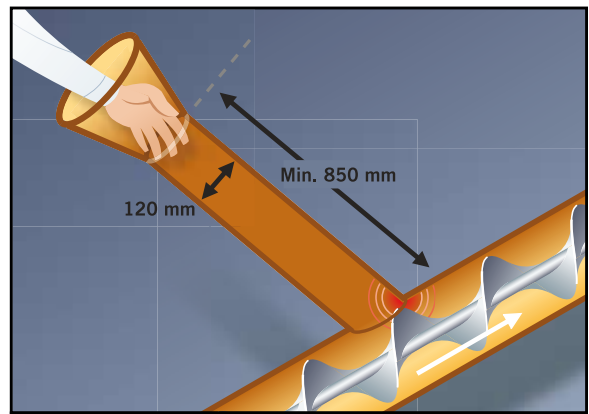

FIGURE 5-9: SAFEGUARDING BY DISTANCE FOR A WORM DRIVE

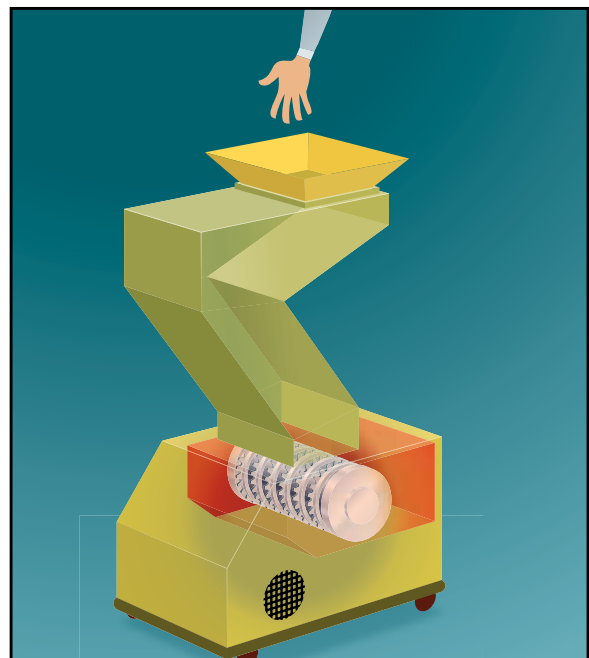

FIGURE 5-10: PLASTIC CRUSHER EQUIPPED WITH CHICANES



FIGURE 5-11: ACCESS FROM BELOW A GUARD

5.4.1 Lower and upper limbs

If the risk assessment determines that there is a risk of access to the danger zone by reaching under the guard for the lower and upper limbs, the minimum safety distance “sd” for an opening of given dimensions must be the longest safety distance appearing in Table 5-3 or in Table 5-4.

The opening’s “e” dimension corresponds to one side of a square-shaped opening, to the diameter of a circular opening, and to the smallest dimension of a slot-shaped opening (see Figure 5-7).

TABLE 5-4: REACHING UNDER A GUARD (LOWER LIMBS ONLY) [22]				
Part of lower limb	Illustration	Opening (mm)	Safety distance «sd» (mm)	
			Slot	Square or round
Toe tip		$e \leq 5$	0	0
Toe		$5 < e \leq 15$	≥ 10	0
		$15 < e \leq 35$	$\geq 80^*$	≥ 25
Foot		$35 < e \leq 60$	≥ 180	≥ 80
		$60 < e \leq 80$	≥ 650	≥ 180
Leg (toe tip to knee)		$80 < e \leq 95$	≥ 1100	≥ 650
Leg (toe tip to crotch)		$95 < e \leq 180$	≥ 1100	≥ 1100
		$180 < e \leq 240$	not admissible	≥ 1100
Whole body		Attention: Slot openings with “e” > 180 mm or square or round openings with “e” > 240 mm allow access for the whole body. These dimensions are not permitted.		

* If the length of the slot opening is ≤ 75 mm, the distance can be reduced to ≥ 50 mm.

5.4.2 Lower limbs only

If the risk assessment determines that a hazard exists only for the lower limbs, the minimum safety distance “**sd**” must be taken from Table 5-4

5.4.3 Limiting movement

Lower and upper limb movement can also be limited (see point 5.3.3). However, the differences in lower and upper limb geometry must be taken into account when movement restrictors are being designed.

Section 6

Protection of in-running nips

In-running nips, or convergence zones, or nip points, are danger zones where parts of the body can be drawn in or crushed. Machines (conveyors, printing presses, paper machines, etc.) can have many in-running nips.

6.1 Creation of in-running nips

In-running nips can be created either:

- ▶ by cylinders in contact (or very close) turning in opposite directions (see Figure 6-1);
- ▶ by two cylinders not in contact (see Figure 6-2);
- ▶ by a cylinder close to a stationary object (see Figure 6-3);
- ▶ by a cylinder in contact with a belt (chain) or the worked material (see Figure 6-4).

Cylinders in contact, power-operated or not, create an in-running nip that can draw in the worker entering the danger zone. If the part of the body (skin, hair, etc.) or the part of clothing being drawn in adheres strongly and the rollers exert great pressure on it, the crushing hazard increases when the cylinders are large in diameter.

Two cylinders not in contact and turning in opposite directions or two cylinders not in contact turning in the same direction²³, with different circumferential velocities or different coefficients of friction, create an in-running nip that can draw in the worker entering the danger zone.

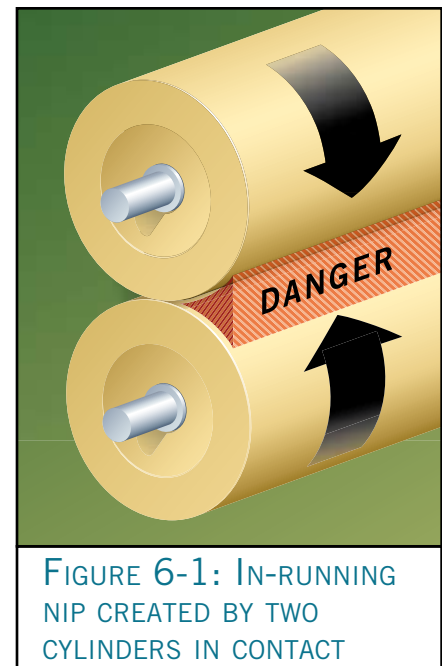

FIGURE 6-1: IN-RUNNING NIP CREATED BY TWO CYLINDERS IN CONTACT

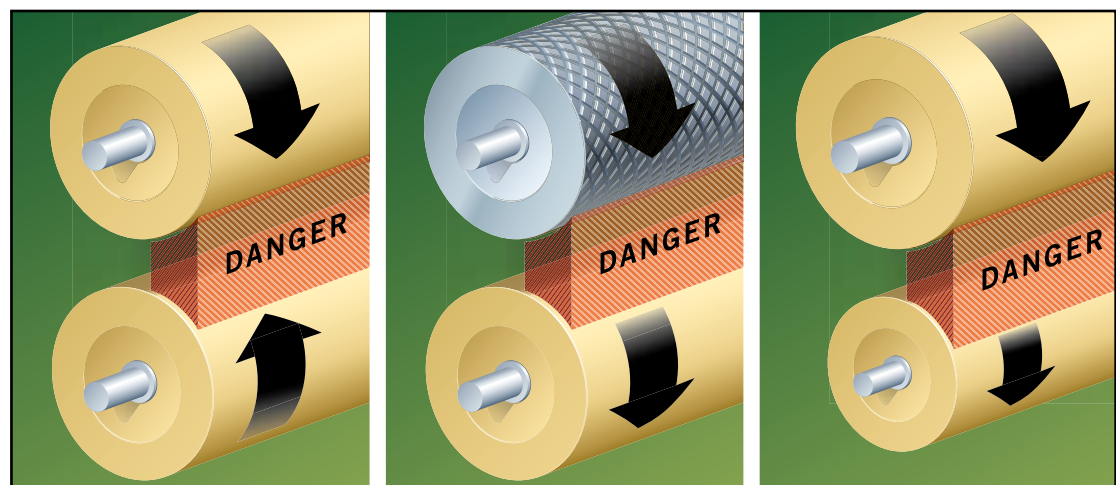

FIGURE 6-2: IN-RUNNING NIPS CREATED BY TWO CYLINDERS NOT IN CONTACT (IDENTICAL, WITH A DIFFERENT COATING OR A DIFFERENT DIAMETER)

23. Two identical cylinders turning in the same direction at the same velocity do not create an in-running nip between them.

Also, a cylinder rotating (in one direction or in both directions) close to a stationary component creates an in-running nip that can draw in a worker who enters the danger zone.

Finally, a cylinder in contact with a belt (conveyor, transmission belt, chain, etc.) or with the material used (sheet of paper or metal, fabric, etc.) creates one in-running nip; if the cylinder rotates in both directions, it creates two in-running nips.

By applying the risk reduction hierarchy in Figure 1 (see Introduction), the in-running nip's danger zone can be protected by inherently safe design, by a fixed enclosing guard, by a fixed distance guard, or by a fixed nip guard.

If the in-running nip can be eliminated in the design step (for example, by replacing the roller by a sliding shoe), this inherently safe design solution must be favoured.

If the in-running nip cannot be eliminated in the design step, but its effects can (e.g., the parts of the body exposed to the hazard are not drawn in, or a retractable cylinder is used - the force suggested to move the cylinder must be less than 110 N [23]), this risk reduction solution can be used (see Figure 6-5).

If the in-running nip cannot be eliminated, a fixed enclosing guard should be used to protect the workers from the hazards. Finally, a fixed nip guard can be used if the residual risk is acceptable or the fixed enclosing guard is not compatible with the machine's functions or with the workers' tasks.

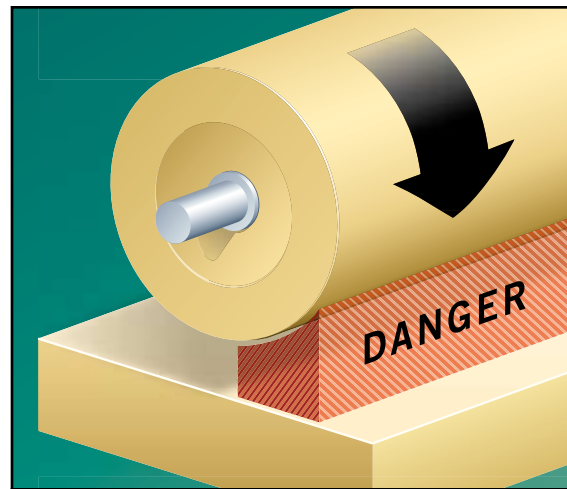

FIGURE 6-3: IN-RUNNING NIP CREATED BY A CYLINDER CLOSE TO A STATIONARY OBJECT

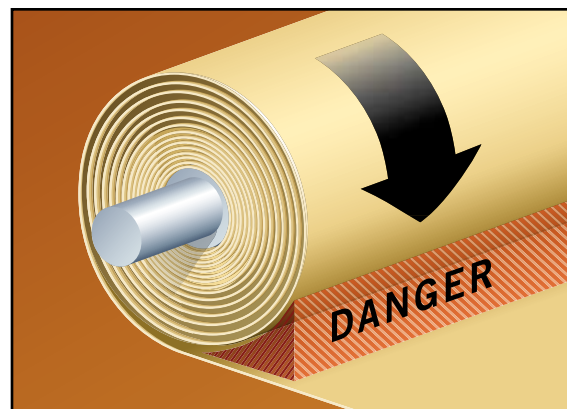

FIGURE 6-4: IN-RUNNING NIP CREATED BY THE WINDING OF MATERIAL

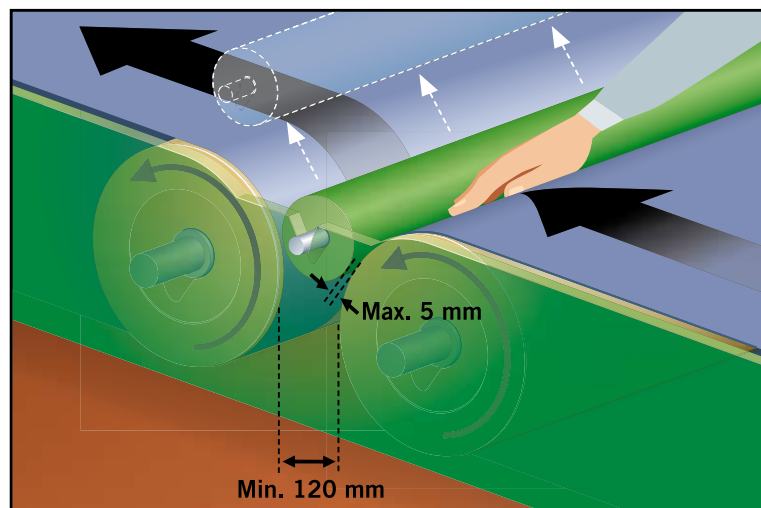

FIGURE 6-5: USE OF A RETRACTABLE CYLINDER AT THE JUNCTURE BETWEEN TWO CONVEYOR BELTS

6.2 Delimiting the drawing-in zone

All in-running nips create danger zones, also called drawing-in zones, whose depth “p” varies with the diameter of the cylinders. The safety distance “sd” must then be measured in relation to the accessible end of this drawing-in zone (called the “perimeter of the drawing-in zone”), and not in relation to the axis of the cylinders of the in-running nip (see Figure 6-6).

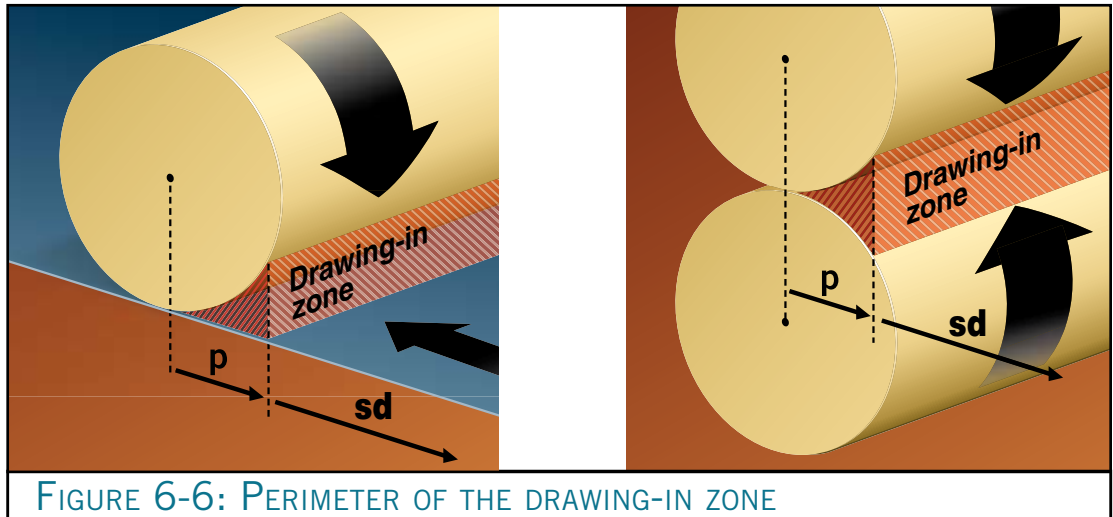

FIGURE 6-6: PERIMETER OF THE DRAWING-IN ZONE

In the case of two cylinders in contact (see Figure 6-7), the shape of the drawing-in zone is an angle that becomes even more acute when the cylinder radii are large. The danger zone is the angle between the two cylinders and is 12 mm in height.

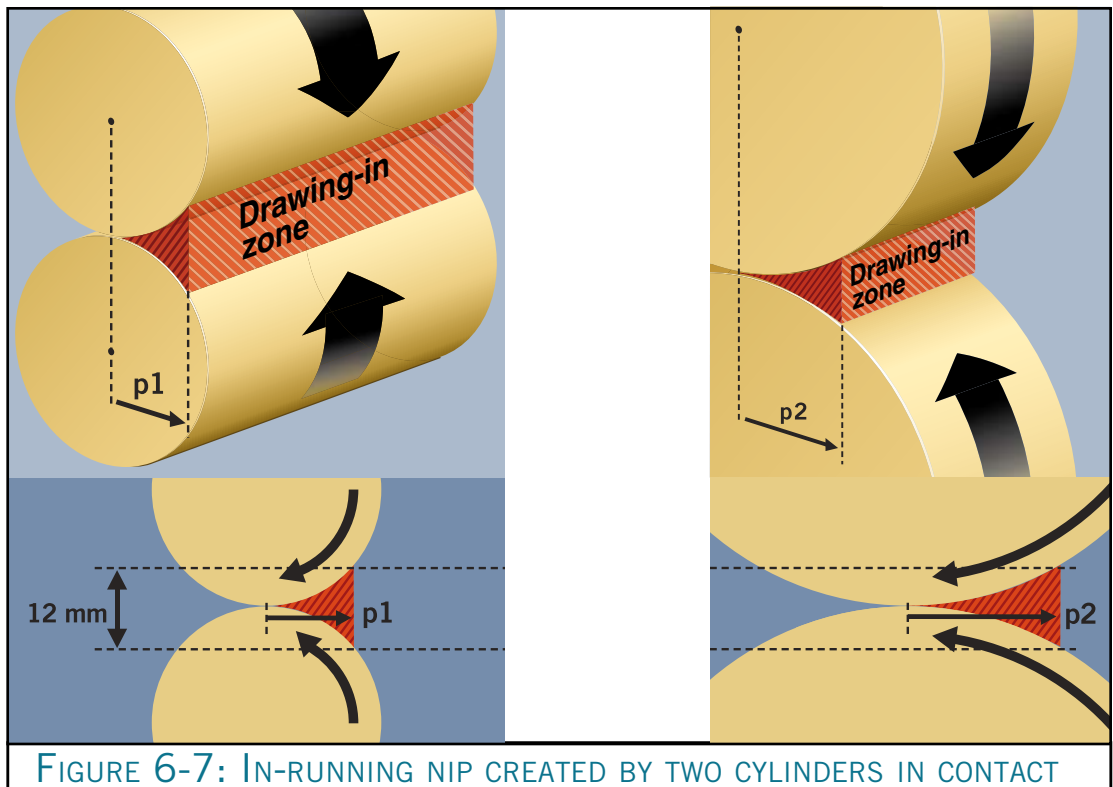

FIGURE 6-7: IN-RUNNING NIP CREATED BY TWO CYLINDERS IN CONTACT

The perimeter of drawing-in zone “p1” or “p2” is determined by the 12-mm distance and the diameter of the cylinders.

In the case of a reel or a cylinder in contact with a belt (see Figure 6-8), the drawing-in zone has the shape of a triangle that becomes even more acute when the cylinder radius is large. The danger zone consists of the triangle between the cylinder and the belt and is 12 mm in height.

In the case of two cylinders in contact with a sheet of material (fabric, steel, belt, laminated material, etc.), the drawing-in zone has two parts (see Figure 6-9), one below the sheet and the other above.

In the case of two cylinders not in contact, or a cylinder close to a stationary component, the depth of the drawing-in zone varies in relation to:

- ▶ the diameter of the cylinders; and
- ▶ the gap between the cylinders; or
- ▶ the gap between the cylinder and the stationary component.

The depth of the drawing-in zone can then be zero ($p = 0$), and therefore the perimeter of the drawing-in zone can be confused with the axis of the cylinders if the gap is greater than 12 mm (see Figure 6-10).

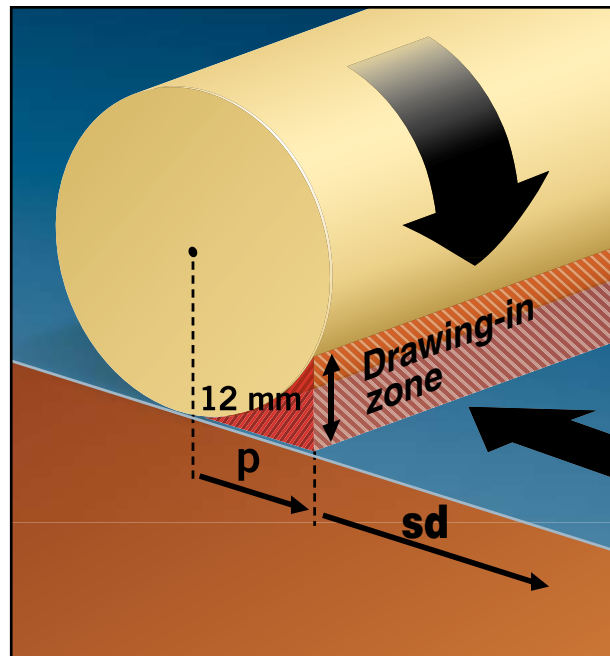

FIGURE 6-8: IN-RUNNING NIP CREATED BY A CYLINDER IN CONTACT WITH A BELT

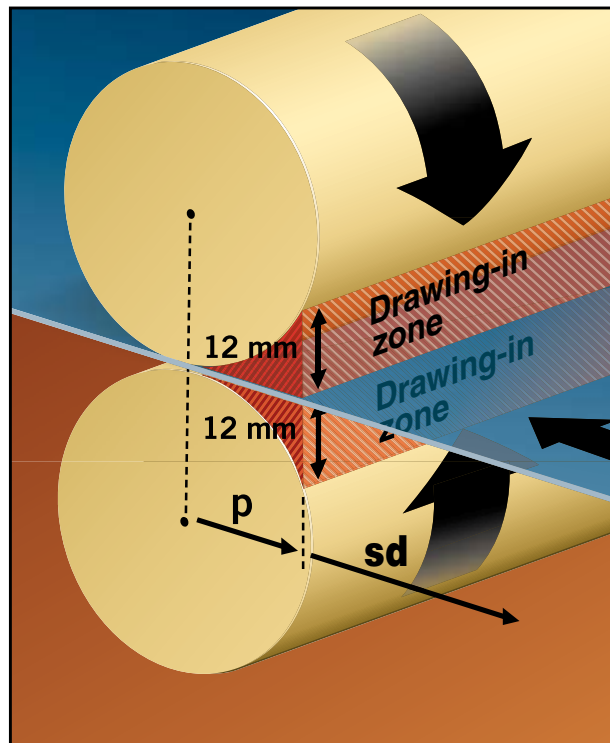

FIGURE 6-9: IN-RUNNING NIP CREATED BY TWO CYLINDERS IN CONTACT WITH A SHEET OF MATERIAL

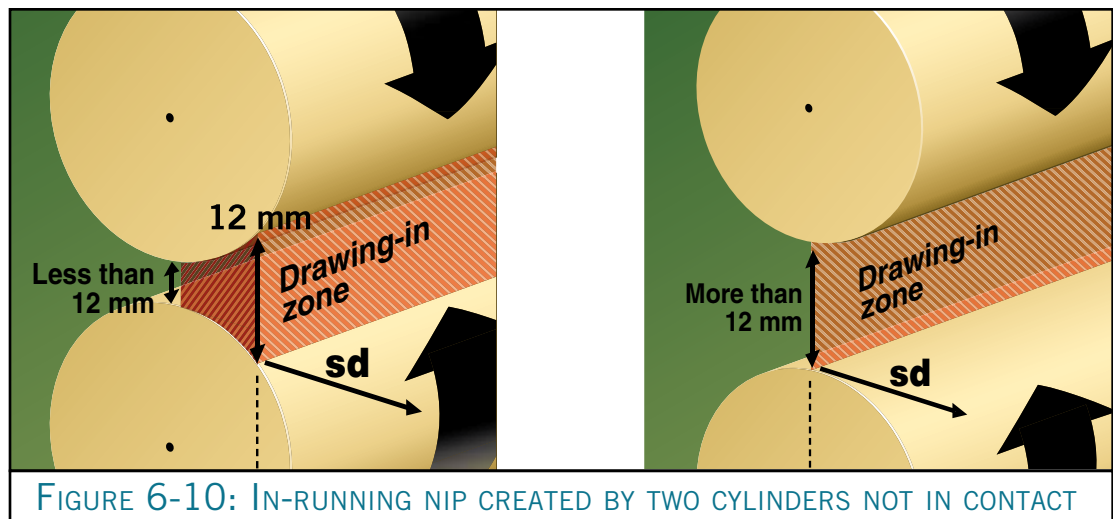

FIGURE 6-10: IN-RUNNING NIP CREATED BY TWO CYLINDERS NOT IN CONTACT

6.3 General information on the use of fixed nip guards

Fixed nip guards (see Figure 6-11) prevent access only to the in-running nip's drawing-in zone. Where feasible, the nip guards must fill the drawing-in zone as much as possible²⁴ and must be sufficiently rigid²⁵ not to increase the clearance between the guard and the cylinders or the belt. The angle between the guard and the cylinder, the belt or the material driven by the cylinder must be at least 60° and ideally 90°.

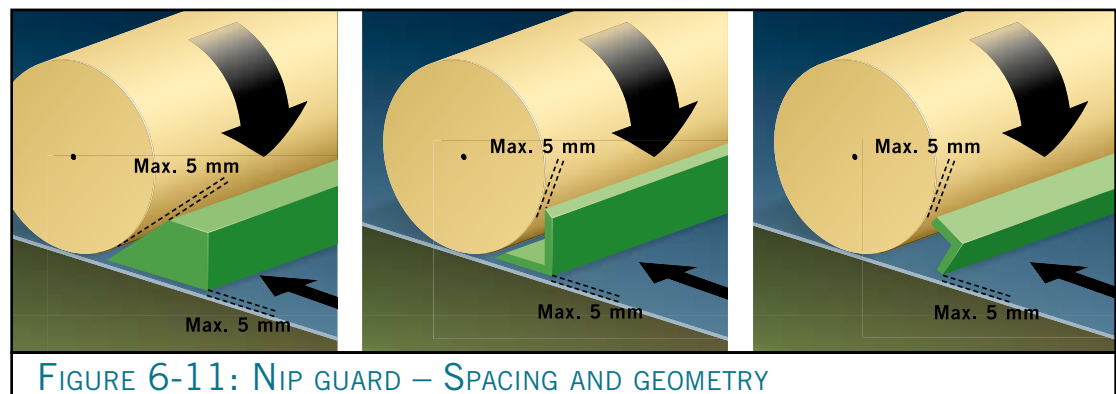



FIGURE 6-11: NIP GUARD – SPACING AND GEOMETRY

However, fixed nip guards do not protect against the risk of pinching between the guard and the cylinder or belt, and residual risks of abrasion or burns may remain.

In addition, they do not provide appropriate protection against the risks of hair or clothing being drawn in. Therefore, the risk analysis must take into account the fact that the drawing-in effect increases with the diameter of the rollers, their roughness, their rotational velocity and the clothing or personal protective equipment worn (gloves, for example).



The use of a nip guard is prohibited:

- ▶ if the maximum clearance of 5 mm cannot be maintained between the guard and the surface of the cylinder and belt;
- ▶ if the cylinder or the belt is not smooth (grooves, burrs, unevenness, notches, ribs, corrugated rubber, abrasive fabric, etc.)²⁶.

24. Remember that the danger zone can be accessed from the sides of the in-running nip.

25. See point 2.2 of [23] and point 6.1 of [24].

26. See ISO 11111-1:2005 [25], for example, for the textile industry.

To limit the risks of pinching, abrasion and burns, the clearance between the guard and the cylinder or belt must be as small as possible (maximum 5 mm), and the angle between the guard and the tangent to the cylinder or between the guard and the belt must be 90° or slightly larger.

Nip guards are particularly suitable for cylinders, drums and rollers with a smooth and full end disc. They can be used with a smooth, flat or troughed belt, if they follow the profile of the belt, and the belt is tight and does not vibrate.

Also, protective devices (that immediately stop the machine before a worker can reach the danger zone) can also be used to protect access to the danger zone of in-running nips (for example, trip bar, sensing bar²⁷ or safety light curtain).

6.3.1 Protection of two cylinders in contact

The nip guard must prevent access to the entire danger zone. It is located at the safety distance “sd” from the perimeter of the drawing-in zone, which establishes the beginning of the drawing-in zone. The safety distance “sd” depends on dimension “e” and the shape of the opening (see point 5.3). Figure 6-12 illustrates several types of acceptable nip guards for protecting two cylinders in contact. A cylindrical rod must not be used.

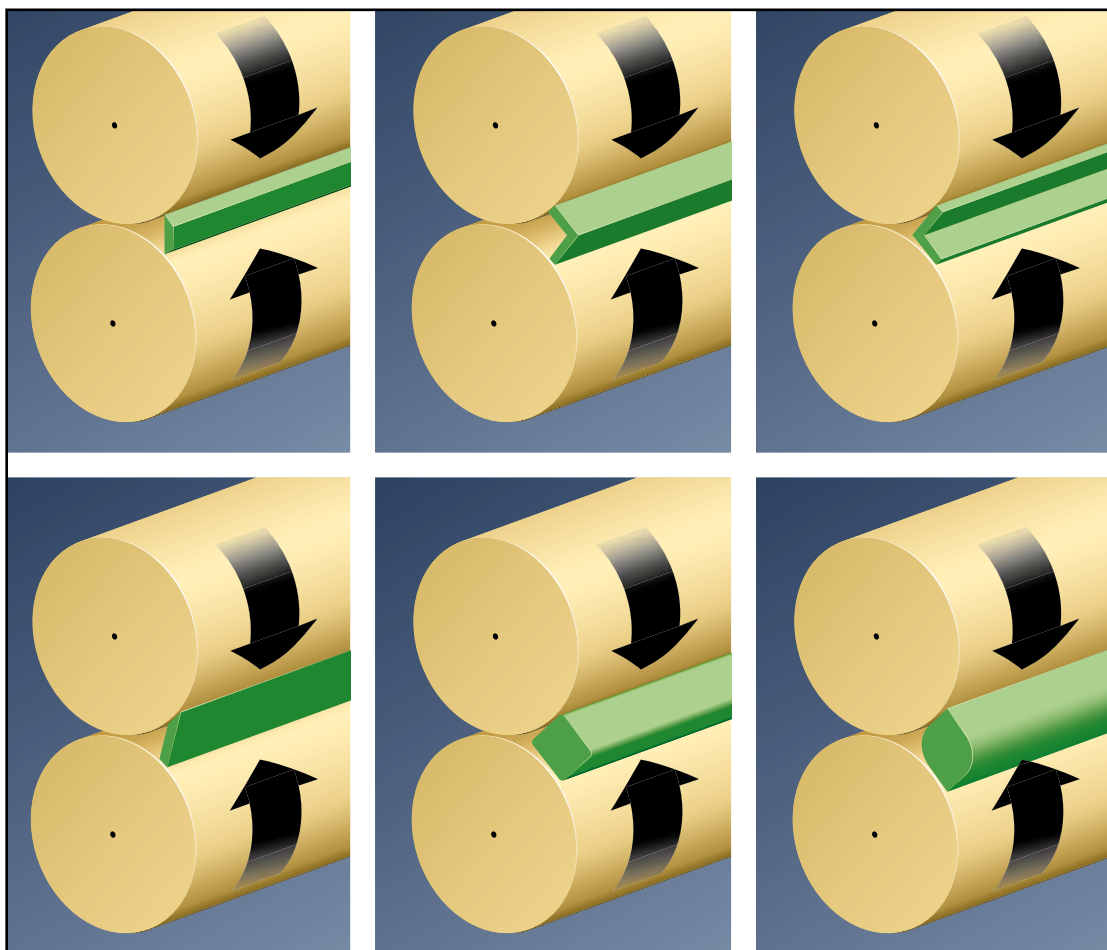

FIGURE 6-12: NIP GUARD FOR TWO CYLINDERS IN CONTACT [24]

27. See, for example, for the printing sector, standards EN 1010-1:2005 [5] and ANSI B65.1-2005 [24].

6.3.2 Protection of two cylinders not in contact

The drawing in of a hand, arm or the entire body between two cylinders not in contact can be prevented in the design step. If the gap between the two rollers is at least 100 mm, 120 mm or 300 mm, then the in-running nip will no longer be considered as hazardous for hands, arms (see Figure 6-13) or the entire body. However, another safeguard must be provided to limit access to the danger zone if the gap is less than 300 mm.

If minimum-gap safeguarding (see point 4.1) is impossible or the residual risk (of abrasion, burns, drawing in, etc.) is unacceptable, a fixed nip guard (see point 6.3) or safeguarding by distance must then be used (see Section 5).

6.3.3 Protection of a cylinder close to a stationary component

The possibilities of a hand, arm or the entire body being drawn in between a cylinder and a close stationary component can be eliminated in the design step. If the gap between the cylinder and the stationary component is at least 100 mm, 120 mm or 300 mm, then the in-running nip will no longer be considered as hazardous for a hand, arm (see Figure 6-14) or the entire body. However, another safeguard must be provided in order to limit access to the danger zone if the gap is less than 300 mm.

If minimum-gap safeguarding (see point 4.1) is impossible or the residual risk (of abrasion, burns, drawing in, etc.) is unacceptable, a fixed nip guard (see point 6.3) or safeguarding by distance must then be used (see Section 5).

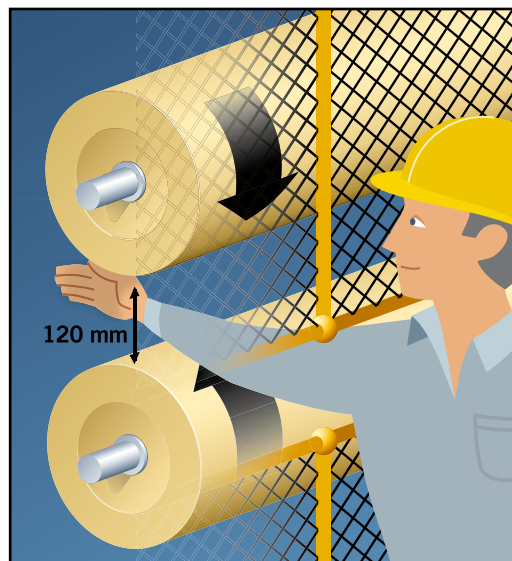

FIGURE 6-13: PREVENTION DURING THE DESIGN STEP FOR TWO CYLINDERS NOT IN CONTACT

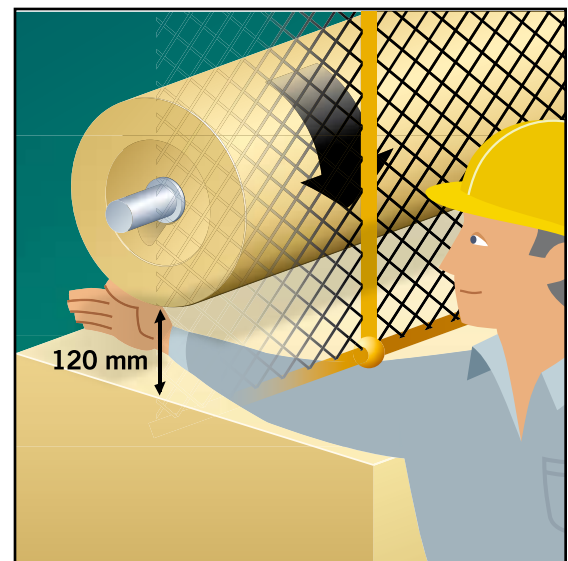

FIGURE 6-14: PREVENTION DURING THE DESIGN STEP FOR ONE CYLINDER AND ONE STATIONARY COMPONENT

6.3.4 Protection of a cylinder in contact with a stationary flat surface

The nip guard must be located at the safety distance “sd” from the drawing-in zone (see Figure 6-15). The data relating to the safety distance “sd” are specified in Table 5-3. The thickness of the material must be taken into account in determining the height “e” of the opening and in verifying whether the safety distance “sd” is sufficient when the material is not present.

6.3.5 Protection of a cylinder in contact with a belt or a flat moving component

Nip guards can consist of solid shapes or angled deflectors with side panels (see Figure 6-16).

In the case of conveyors, the solutions are described in the guide entitled *A User’s Guide to Conveyor Belt Safety – Protection from Danger Zones* [13].

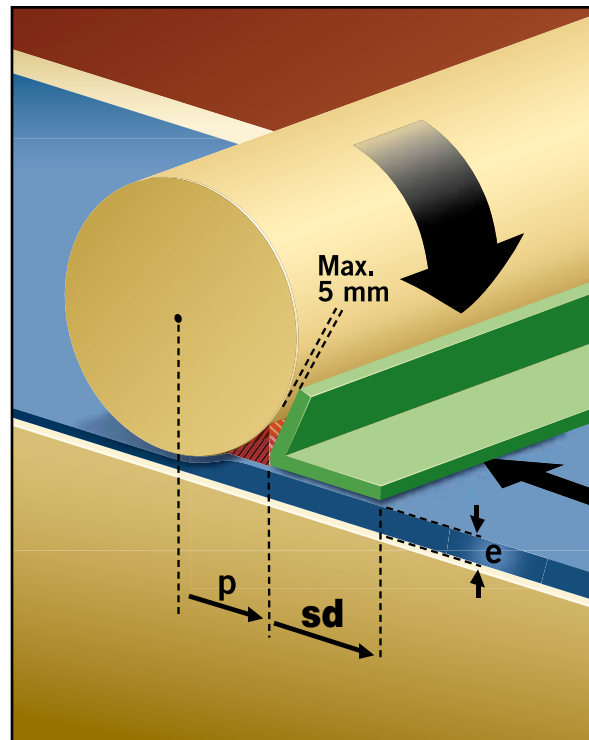

FIGURE 6-15: NIP GUARDS FOR A CYLINDER IN CONTACT WITH A STATIONARY FLAT SURFACE

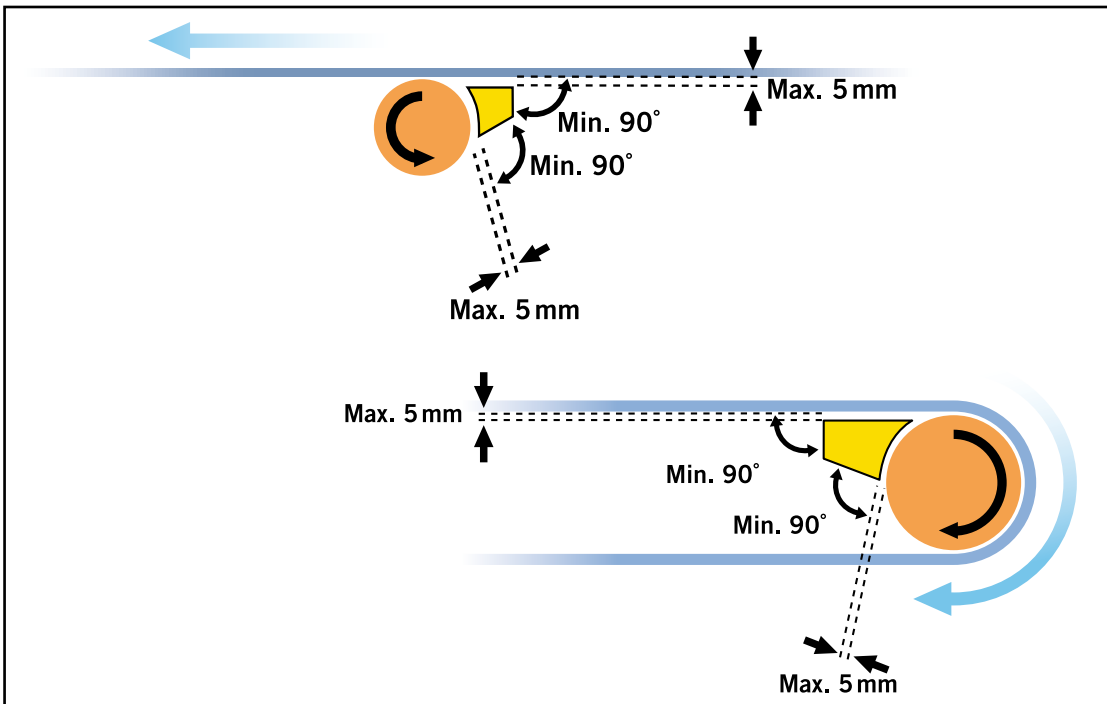

FIGURE 6-16: NIP GUARDS FOR A CYLINDER IN CONTACT WITH A BELT

Appendix A

Quick reference: Hazards

QUICK REFERENCE

HAZARDS

1. Mechanical hazards

1.1 Factors to consider

- ◆ Mass, velocity (kinetic energy of the controlled or uncontrolled moving components)
- ◆ Acceleration, force
- ◆ Potential energy, namely the accumulation of energy inside the machine produced by:
 - elastic components (springs, etc.)
 - gases/liquids under pressure (hydraulic, pneumatic, etc.)
 - vacuum/pressure effect

1.2 Hazards associated with components and tools

- ◆ Moving components and tools
- ◆ Relative location of moving components and tools
- ◆ In-running nips (rollers, conveyors, etc.)
- ◆ Inadequate strength
- ◆ Hazardous shapes (cutting, pointed, rough, etc.)
(see examples)

1.3 Hazards associated with gravity

- ◆ Mass and stability (components or worker falling under the effect of their weight)
(see examples)

2. Electrical hazards

- ◆ Live conductors
- ◆ Live machine components
- ◆ Electrostatic hazards

3. Thermal hazards

- ◆ Objects or materials at extreme temperatures (high or low)
- ◆ Presence of flame or explosion; presence of water and molten metal
- ◆ Radiation from sources of heat; cold or hot work environment, etc.

4. Noise

5. Vibration

6. Radiation

- ◆ Low frequency, radio frequency, microwave, X-ray and gamma radiation,
- ◆ Laser/infrared, visible and ultraviolet light, etc.



7. Hazards produced by materials, products, contaminants

- ◆ Hazardous materials (harmful, toxic, corrosive, reactive, humid, teratogenic, carcinogenic, mutagenic or irritating)
- ◆ Infectious materials, and combustible, flammable, oxidizing or explosive materials, compressed gases, etc.

8. Hazards produced by non-respect of ergonomic principles

- ◆ Nonneutral posture, force, repetition, absence of micro-breaks, frequent handling
- ◆ Inadequate lighting, etc.
- ◆ Inadequate visibility, poor location of controls
- ◆ Difficult access to the working space, layout of premises, etc.

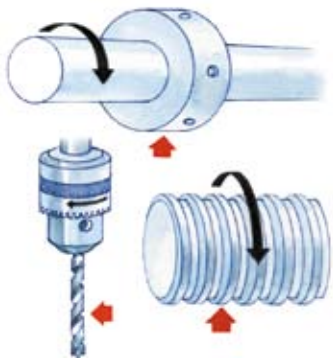
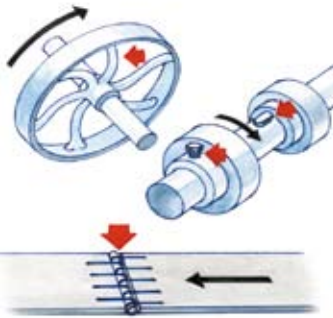
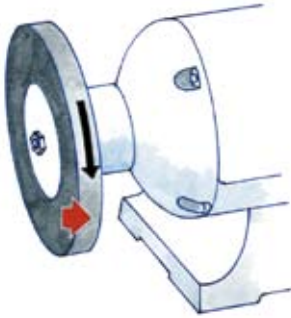
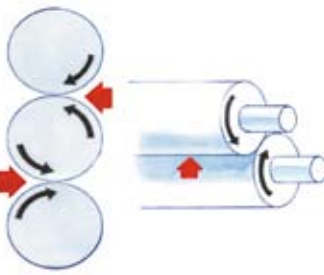
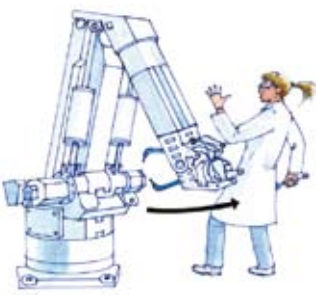
EXAMPLES OF MECHANICAL HAZARDS ASSOCIATED WITH COMPONENTS AND TOOLS

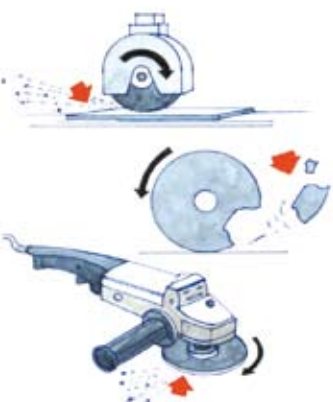
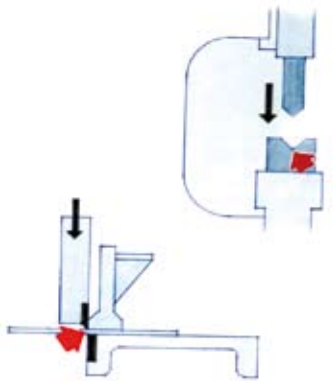
Hazard	Possible consequences	Hazard	Possible consequences
	<ul style="list-style-type: none"> ● Winding ● Entanglement ● Drawing in 		<ul style="list-style-type: none"> ● Winding ● Entanglement ● Impact ● Crushing ● Drawing in ● Burning ● Puncture
	<ul style="list-style-type: none"> ● Entanglement ● Abrasion ● Drawing in ● Burning ● Projection 		<ul style="list-style-type: none"> ● Drawing in ● Crushing ● Burning
	<ul style="list-style-type: none"> ● Impact ● Crushing 		<ul style="list-style-type: none"> ● Drawing in ● Abrasion
	<ul style="list-style-type: none"> ● Stabbing ● Projection ● Burning ● Impact 		<ul style="list-style-type: none"> ● Crushing ● Shearing ● Severing ● Projection



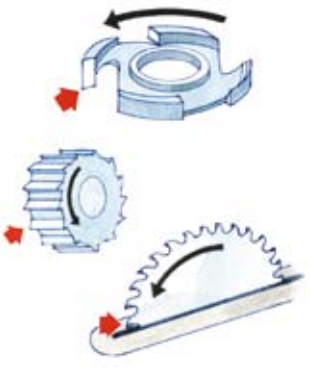
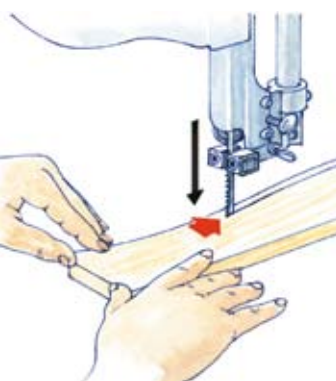
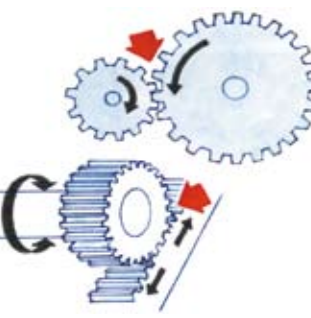
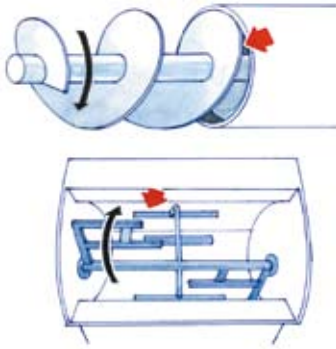
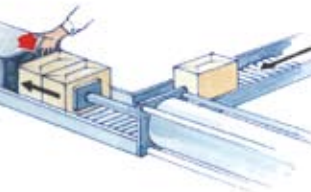
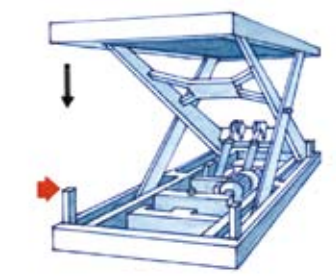
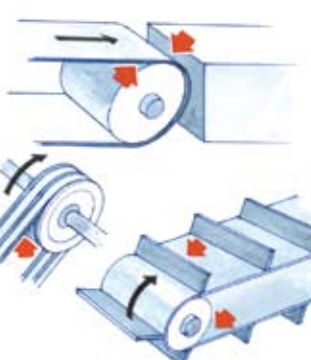
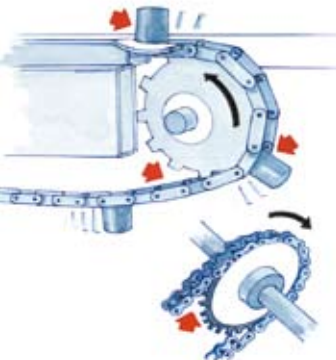

EXAMPLES OF MECHANICAL HAZARDS ASSOCIATED WITH COMPONENTS AND TOOLS

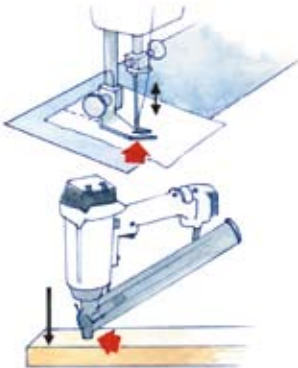
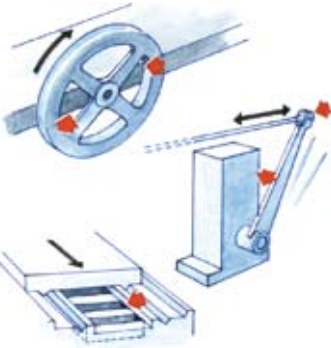
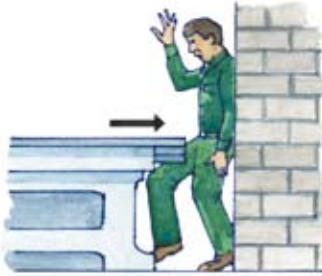
Hazard	Possible consequences	Hazard	Possible consequences
	<ul style="list-style-type: none"> ● Cutting ● Severing ● Projection ● Drawing in 		<ul style="list-style-type: none"> ● Cutting ● Severing ● Projection
	<ul style="list-style-type: none"> ● Drawing in ● Crushing ● Severing 		<ul style="list-style-type: none"> ● Winding ● Entanglement ● Impact ● Drawing in ● Severing ● Shearing
	<ul style="list-style-type: none"> ● Shearing ● Severing ● Drawing in ● Crushing ● Impact 		<ul style="list-style-type: none"> ● Crushing ● Shearing ● Severing
	<ul style="list-style-type: none"> ● Drawing in ● Crushing ● Tearing out ● Severing ● Impact 		<ul style="list-style-type: none"> ● Drawing in ● Crushing ● Tearing out ● Severing ● Impact

EXAMPLES OF MECHANICAL HAZARDS ASSOCIATED WITH COMPONENTS AND TOOLS

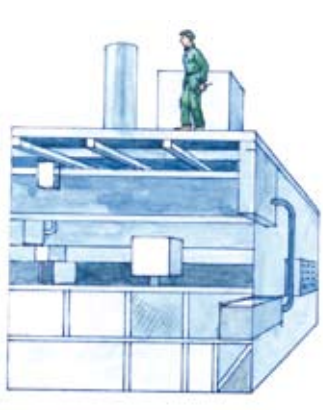
Hazard	Possible consequences	Hazard	Possible consequences
	<ul style="list-style-type: none"> ● Impact ● Crushing ● Drawing in 		<ul style="list-style-type: none"> ● Stabbing ● Puncture ● Punching ● Projection
	<ul style="list-style-type: none"> ● Shearing ● Severing ● Winding ● Entanglement ● Impact ● Crushing ● Drawing in 		<ul style="list-style-type: none"> ● Impact ● Crushing

EXAMPLES OF HAZARDS ASSOCIATED WITH GRAVITY

Hazard	Possible consequences	Hazard	Possible consequences
	<ul style="list-style-type: none"> ● Slumping ● Collapse ● Subsidence ● Smothering ● Jamming ● Crushing ● Falling 		<ul style="list-style-type: none"> ● Falling ● Slipping ● Slumping
	<ul style="list-style-type: none"> ● Crushing ● Jamming ● Lowering ● Slumping 		<ul style="list-style-type: none"> ● Falling ● Slipping ● Tripping
	<ul style="list-style-type: none"> ● Impact ● Crushing ● Slumping 		<ul style="list-style-type: none"> ● Falling ● Tripping ● Slipping

Appendix B

Annex B of ISO 14120:2002

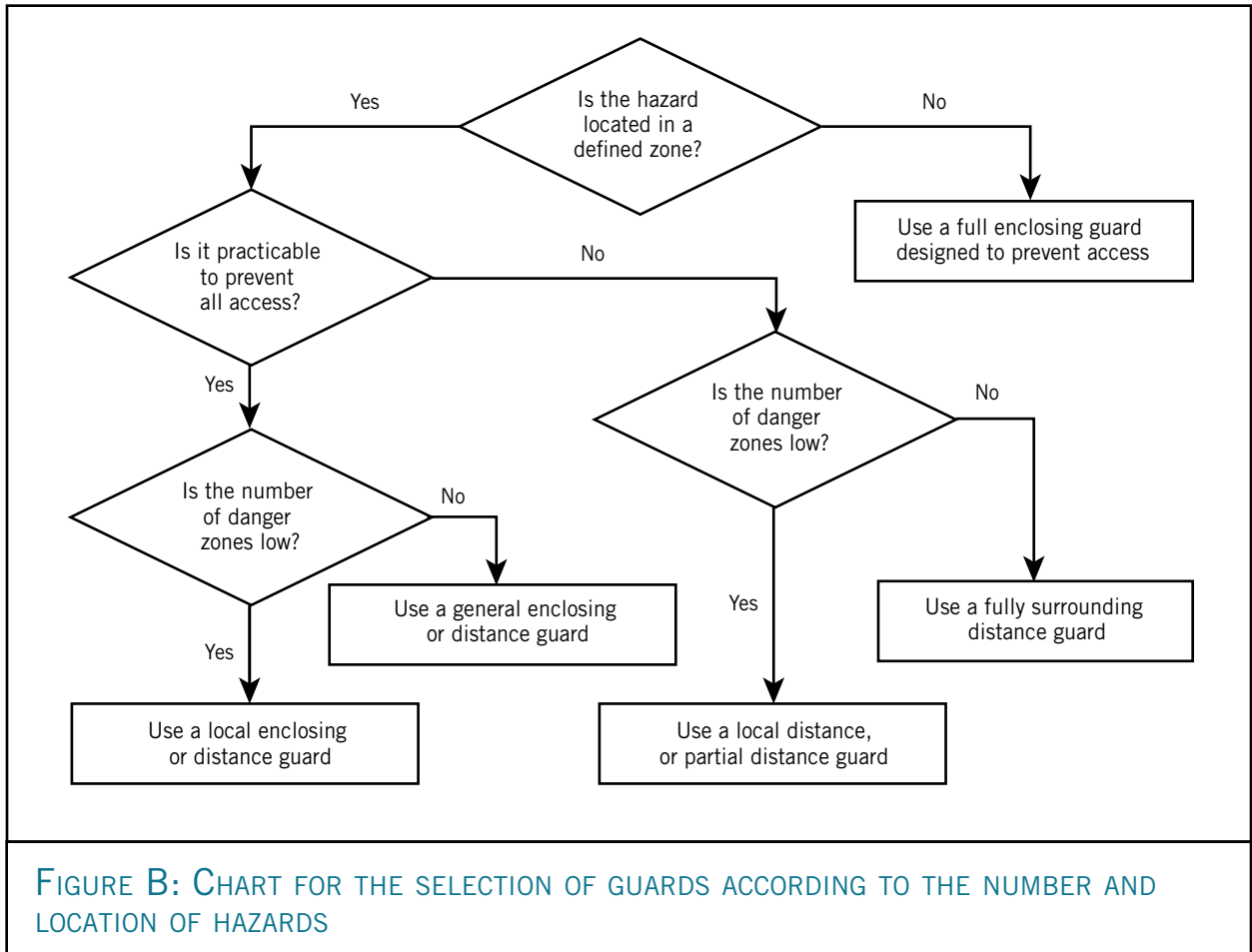

Note. – The definitions of the terms used in this appendix appear in standard [12].

Appendix C

Figure 1 in ISO 12100-2:2003

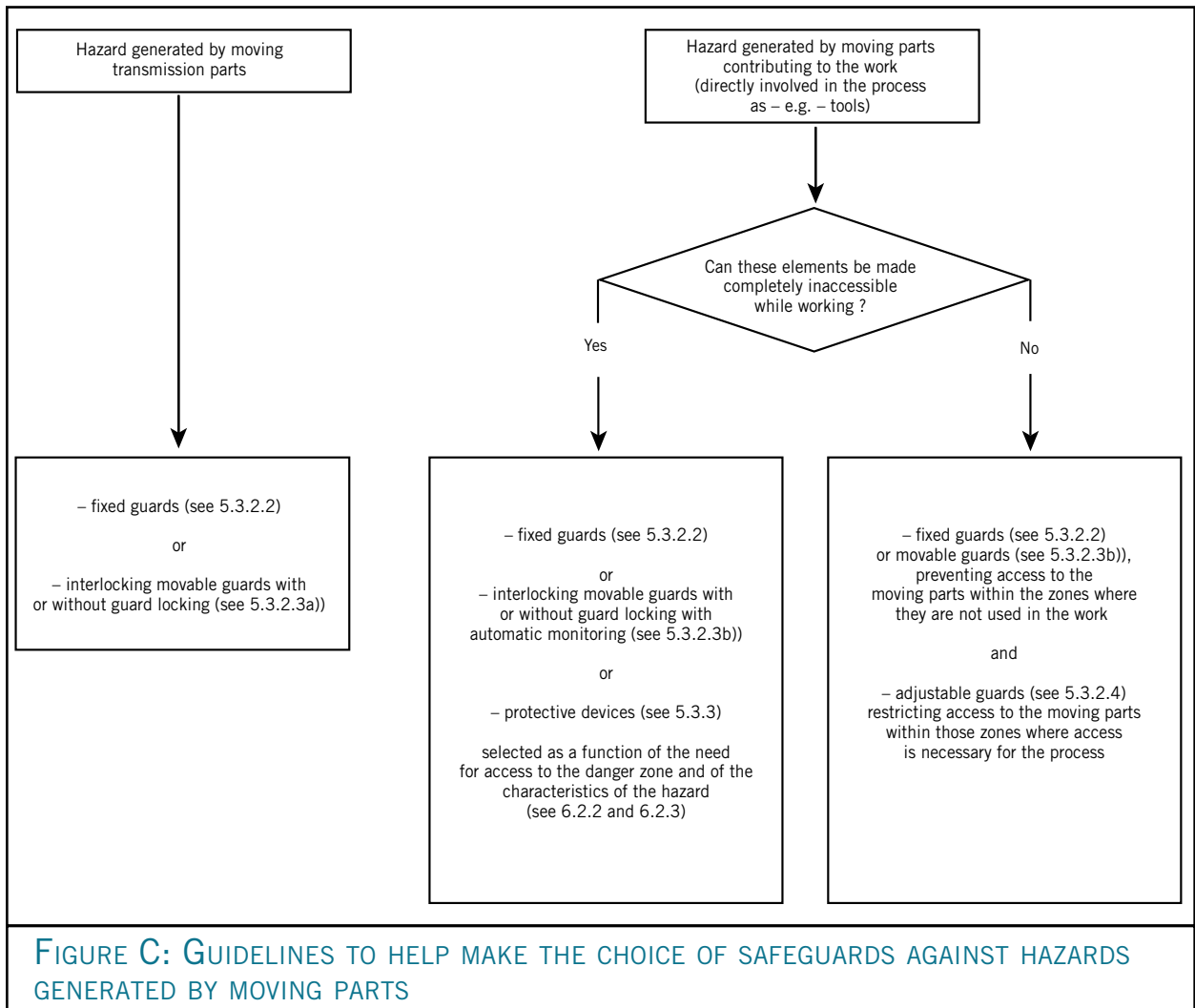

Note. – The definitions of the terms used in this appendix appear in the standard.
Also, the sections mentioned in the figure are those in standard [7].

- Permission to use extracts from ISO 12100-2 :2003 was provided by Standards Council of Canada, in cooperation with IHS Canada. No further reproduction is permitted without prior written approval from Standards Council of Canada.

Annexe D

Examples of use of Tables 5-1 and 5-2

EXAMPLE 1 Calculation of height “b” for a guard – Low risk

Initial data

Height “a” of the danger zone is 1500 mm and its horizontal distance “c” with respect to the planned guard is 700 mm.

Reasoning

The guard providing the greatest safety must always be chosen. Since height “a” (1500 mm) of the danger zone does not appear in Table 5-2 (for low risks), the closest smaller height “a” (1400 mm) and the closest larger height “a” (1600 mm) must be considered. Then, for each of these two “a” heights, you must determine in which interval of Table 5-2 is the horizontal distance “c” of 700 mm, as well as height “b” of the guard corresponding to this interval:

- ▶ When a danger zone is at a height of 1400 mm and at a horizontal distance “c” between 100 mm and 800 mm, height “b” of the guard must be at least 1800 mm;
- ▶ When a danger zone is at a height of 1600 mm and at a horizontal distance “c” between 500 mm and 900 mm, minimum height “b” of the guard must be at least 1800 mm.

In this example, a minimum height “b” of 1800 mm is obtained in both cases.

Solution

The minimum height “b” of the fixed distance guard is therefore 1800 mm when height “a” of the danger zone is 1500 mm, and its horizontal distance “c” with respect to the guard is 700 mm (see Figure D-1).

EXAMPLE 1 – EXCERPT FROM TABLE 5-2

Height of danger zone “a” (mm)	Height of the guard “b” (mm)			
	1400	1600	1800	2000
	Horizontal safety distance → danger zone “c” (mm)			
2500	0	0	0	0
2400	100	100	100	100
2200	500	500	400	350
2000	700	600	500	350
1800	900	900	600	sd
1600	900	900	500	sd
1400	900	800	100	sd
1200	900	500	sd	sd

* Important: Distance “c” is sufficiently large to allow a person to get between the distance guard and the danger zone. This possibility must be taken into consideration when the distance guard is chosen (see point 3.2).

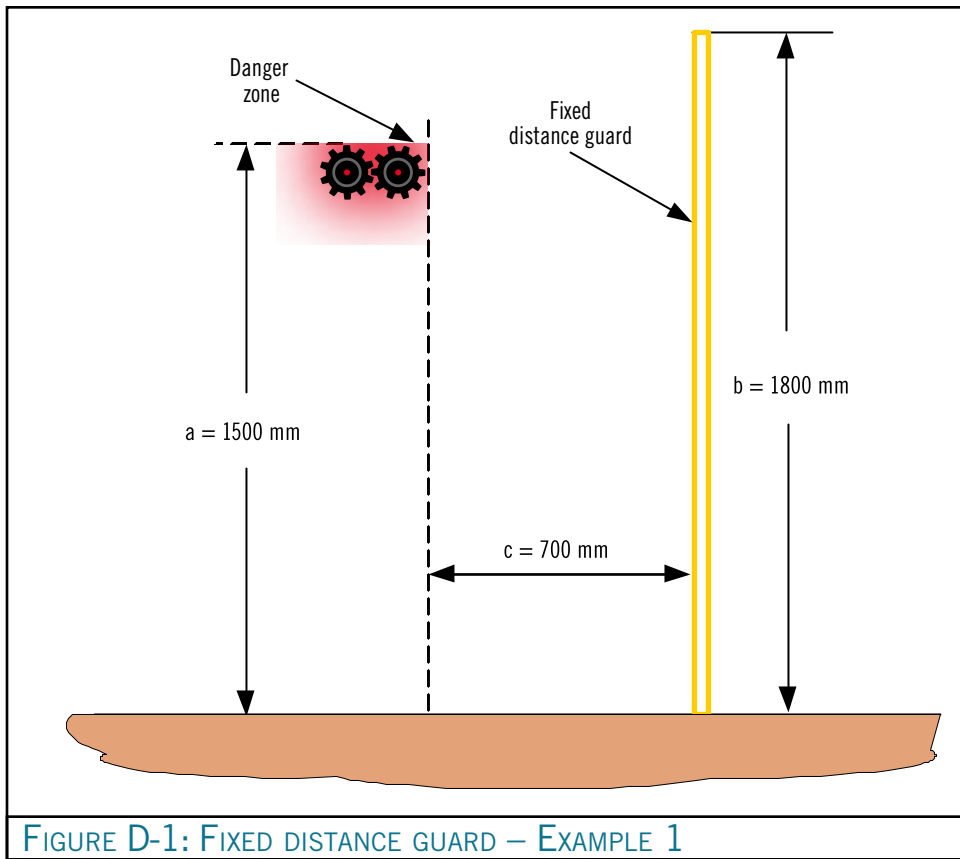

FIGURE D-1: FIXED DISTANCE GUARD – EXAMPLE 1

If the horizontal distance “c”* between the danger zone and the planned guard exceeds 900 mm, the minimum height of the guard could then be 1400 mm.

EXAMPLE 1 (SUITE) – EXCERPT FROM TABLE 5-2

Height of danger zone “a” (mm)	Height of the guard “b” (mm)			
	1400	1600	1800	2000
	Horizontal safety distance to danger zone “c” (mm)			
2500	0	0	0	0
2400	100	100	100	100
2200	500	500	400	350
2000	700	600	500	350
1800	900	900	600	sd
1600	900	900	500	sd
1400	900	800	100	sd
1200	900	500	sd	sd

* Important: Distance “c” is sufficiently large to allow a person to get between the distance guard and the danger zone. This possibility must be taken into consideration when the distance guard is chosen (see point 3.2).

EXAMPLE 2 Calculation of the horizontal distance “c” between the guard and the danger zone – Low risk

Initial data

Height “b” of the guard is 1500 mm and height “a” of the danger zone is 2100 mm.

Reasoning

In Table 5-2 (for low risks), the “c” distances must be considered as permitted when the guard is 1400 or 1600 mm high (the dimension immediately below or above 1500 mm) and the danger zone is located 2000 mm and 2200 mm away. The safest distance must then be chosen.

Solution

Minimum horizontal distance “c”* between the danger zone and the guard is therefore 700 mm when height “b” for the guard is 1500 mm and height “a” for the danger zone is 2100 mm (see Figure D-2).

EXAMPLE 2 – EXCERPT FROM TABLE 5-2				
Height of danger zone “a” (mm)	Height of the guard “b” (mm)			
	1400	1600	1800	2000
	Horizontal safety distance to danger zone “c” (mm)			
2500	0	0	0	0
2400	100	100	100	100
2200	500	500	400	350
2000	700	600	500	350
1800	900	900	600	sd

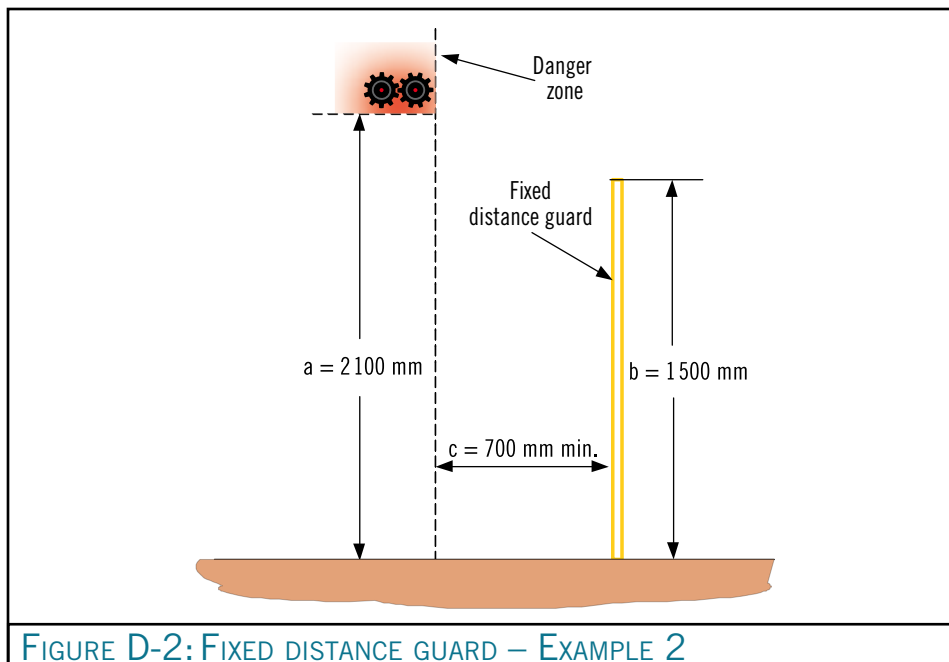

FIGURE D-2: FIXED DISTANCE GUARD – EXAMPLE 2

* Important: Distance “c” is sufficiently large to allow a person to get between the distance guard and the danger zone. This possibility must be taken into consideration when the distance guard is chosen (see point 3.2).

EXAMPLE 3 Calculation of permissible height “a” for the danger zone – High risk

▶ **Initial data**

Height “b” of the guard is 1700 mm and the horizontal distance “c” with respect to the danger zone is 850 mm.

▶ **Reasoning**

First, the data in Table 5-1 (for high risks) must be used, and then the horizontal distances “c” that are permissible when the guards are 1600 mm and 1800 mm high must be taken into account. Since the permissible “c” distances are greater for a guard 1600 mm high, only these numbers can be used as a basis, since the safest distance must always be chosen.

One must then verify, among the “c” values, which ones are less than or equal to 850 mm. The danger zone can be located at the corresponding “a” heights.

▶ **Solution**

The danger zone must be located less than 1000 mm or more than 2400 mm away when height “b” of the guard is 1700 mm and horizontal distance “c”* with respect to the danger zone is 850 mm.

Distance “c” can even be reduced according to the indications given in Table 5-1 while remaining safe. Also, when the abbreviation “sd” is indicated in the table (for example, when the danger zone is located at a height “a” less than 600 mm), the danger zone must be separated from the guard by a distance that is a function of the size of the “e” openings in the latter. The minimum distance “sd” between the danger zone and the guard is 13 mm, even if the guard does not have an opening in it.

EXAMPLE 3 – EXCERPT FROM TABLE 5-1

Height of danger zone “a” (mm)	Height of the guard “b” (mm)			
	1400	1600	1800	2000
	Horizontal safety distance to danger zone “c” (mm)			
2700	0	0	0	0
2600	700	600	600	500
2400	900	800	700	600
2200	1000	900	800	600
2000	1100	900	800	600
1800	1100	900	800	600
1600	1100	900	800	500
1400	1100	900	800	sd
1200	1100	900	700	sd
1000	1000	800	sd	sd
800	900	600	sd	sd
600	800	sd	sd	sd
400	400	sd	sd	sd
200	sd	sd	sd	sd
0	sd	sd	sd	sd

* Important: Distance “c” is sufficiently large to allow a person to get between the distance guard and the danger zone. This possibility must be taken into consideration when the distance guard is chosen (see point 3.2).

References

- [1] COMMISSION DE LA SANTÉ ET DE LA SÉCURITÉ DU TRAVAIL (CSST). *Sécurité des machines, aide-mémoire : phénomènes dangereux, situations dangereuses, événements dangereux, dommages*, DC 900-337 (04-10), 2004.
- [2] INTERNATIONAL ORGANIZATION FOR STANDARDIZATION. ISO 13849-1:1999, *Safety of machinery -- Safety-related parts of control systems -- Part 1: General principles for design*, 1999.
- [3] INTERNATIONAL ORGANIZATION FOR STANDARDIZATION. ISO 14121:1999, *Safety of machinery -- Principles of risk assessment*, 1999.
- [4] INTERNATIONAL ORGANIZATION FOR STANDARDIZATION. ISO 12100-1:2003, *Safety of machinery -- Basic concepts, general principles for design -- Part 1: Basic terminology*, 2003.
- [5] COMITÉ EUROPÉEN DE NORMALISATION. EN 1010-1:2005, *Safety of machinery - Safety requirements for the design and construction of printing and paper converting machines - Part 1: Common requirements*, 2005.
- [6] INTERNATIONAL ORGANIZATION FOR STANDARDIZATION. ISO 11161:2007, *Safety of machinery -- Integrated manufacturing systems -- Basic requirements*, 2007.
- [7] INTERNATIONAL ORGANIZATION FOR STANDARDIZATION. ISO 12100-2:2003, *Safety of machinery -- Basic concepts, general principles for design -- Part 2: Technical principles*, 2003.
- [8] GOUVERNEMENT DU QUÉBEC. *An Act respecting occupational health and safety (AOHS)*, R.S.Q., c. S-2.1. Can be consulted at the CSST's website : www.csst.qc.ca.
- [9] GOUVERNEMENT DU QUÉBEC. *Regulation respecting occupational health and safety (ROHS)*, c. S-2.1, r. 19.01, December 2006. Can be consulted at the CSST's website: www.csst.qc.ca.
- [10] INTERNATIONAL ORGANIZATION FOR STANDARDIZATION. ISO 14119:1998, *Safety of machinery -- Interlocking devices associated with guards -- Principles for design and selection*, 1998.
- [11] LUPIN, Henri et Jacques MARSOT. *Sécurité des machines et des équipements de travail – Moyens de protection contre les risques mécaniques*, INRS, ED 807, 2006.
- [12] INTERNATIONAL ORGANIZATION FOR STANDARDIZATION. ISO 14120:2002, *Safety of machinery -- Guards -- General requirements for the design and construction of fixed and movable guards*, 2002.
- [13] COMMISSION DE LA SANTÉ ET DE LA SÉCURITÉ DU TRAVAIL (CSST). *Sécurité des convoyeurs à courroie, généralités, protection contre les phénomènes dangereux, guide de l'utilisateur*, DC 200-16227-1 (04-01), Montréal, CSST, 2004.
An English version "A User's Guide to Conveyor Belt Safety – Protection from Danger Zones" can be consulted at the IRSST's website : www.irsst.qc.ca.
- [14] BOURBONNIÈRE, Réal et collègues. *Guide de conception des circuits de sécurité : introduction aux catégories de la norme ISO 13849-1:1999 (version corrigée)*, IRSST, 2005. Can be consulted at the IRSST's website : www.irsst.qc.ca.
- [15] INTERNATIONAL ORGANIZATION FOR STANDARDIZATION. ISO 13854:1996, *Safety of machinery -- Minimum gaps to avoid crushing of parts of the human body*, 1996.
- [16] ASSOCIATION INTERNATIONALE DE SÉCURITÉ SOCIALE (AISS). *Prévention des risques mécaniques, solutions pratiques*, ISSA Prevention Series No. 2014 (F), Genève, AISS, 1994.
- [17] CANADIAN STANDARDS ASSOCIATION. CSA Z434-03, *Industrial Robots and Robot Systems: General Safety Requirements*, 2003.
- [18] CANADIAN STANDARDS ASSOCIATION. CSA B44-00, *Safety Code for Elevators*, 2000.
- [19] INTERNATIONAL ORGANIZATION FOR STANDARDIZATION. ISO 13852:1996, *Safety of machinery -- Safety distances to prevent danger zones being reached by the upper limbs*, 1996.

- [20] INTERNATIONAL ORGANIZATION FOR STANDARDIZATION. ISO 13857:2008, *Safety of machinery -- Safety distances to prevent hazard zones being reached by upper and lower limbs*, 2008.
- [21] CANADIAN STANDARDS ASSOCIATION. CSA Z432-04, *Safeguarding of Machinery*, 2004.
- [22] INTERNATIONAL ORGANIZATION FOR STANDARDIZATION. ISO 13853:1998, *Safety of machinery -- Safety distances to prevent danger zones being reached by the lower limbs*, 1998.
- [23] AUSTRALIAN STANDARD. AS 1755-2000, *Conveyors – Safety Requirements*, 2000.
- [24] AMERICAN NATIONAL STANDARD. ANSI B65.1-2005, *Graphic technology – Safety Standard – Printing Press Systems*, 2005.
- [25] INTERNATIONAL ORGANIZATION FOR STANDARDIZATION. ISO 11111-1:2005, *Textile machinery -- Safety requirements -- Part 1: Common requirements*, 2005.

Note. – The documents published by the CSST can be ordered by mentioning the document number (DC) or consulted on line at www.csst.qc.ca. The majority of the documents can be consulted at the CSST's Centre de documentation by mentioning the call number. IRSST and INRS documents can be consulted on their respective websites: www.irsst.qc.ca and www.inrs.fr.

Bibliography

COMMISSION DE LA SANTÉ ET DE LA SÉCURITÉ DU TRAVAIL. *Aide-mémoire : phénomènes dangereux*, DC 100-482-1.

COMMISSION DE LA SANTÉ ET DE LA SÉCURITÉ DU TRAVAIL. *Sécurité des convoyeurs à courroie, principes de conception pour améliorer la sécurité, guide du concepteur*, DC 200-16226, CSST, Montréal, 2004. Can be consulted at the CSST's website : www.csst.qc.ca.

GOUVERNEMENT DU QUÉBEC. *Safety Code for the construction industry*, c. S-2.1, r. 6, 2003. Can be consulted at the CSST's website : www.csst.qc.ca.

GOUVERNEMENT DU QUÉBEC. *Regulation respecting occupational health and safety in mines*, c. S-2.1, r. 19.1, 2006. Can be consulted at the CSST's website : www.csst.qc.ca.

INTERNATIONAL ORGANIZATION FOR STANDARDIZATION. ISO 13855:2002, *Safety of machinery -- Positioning of protective equipment with respect to the approach speeds of parts of the human body*, 2002.

VAILLANCOURT, D.R. et SNOOK, S.H. "A review of Machine-guarding recommendations", *Applied Ergonomics*, Vol. 26, No. 2, 1995, p. 141-145.

Note. – The documents published by the CSST can be ordered by mentioning the document number (DC) or consulted on line at www.csst.qc.ca. The majority of the documents can be consulted at the CSST's Centre de documentation by mentioning the call number. IRSST and INRS documents can be consulted on their respective websites: www.irsst.qc.ca and www.inrs.fr.

