

Design of safety guards

Under observation of ISO 14119

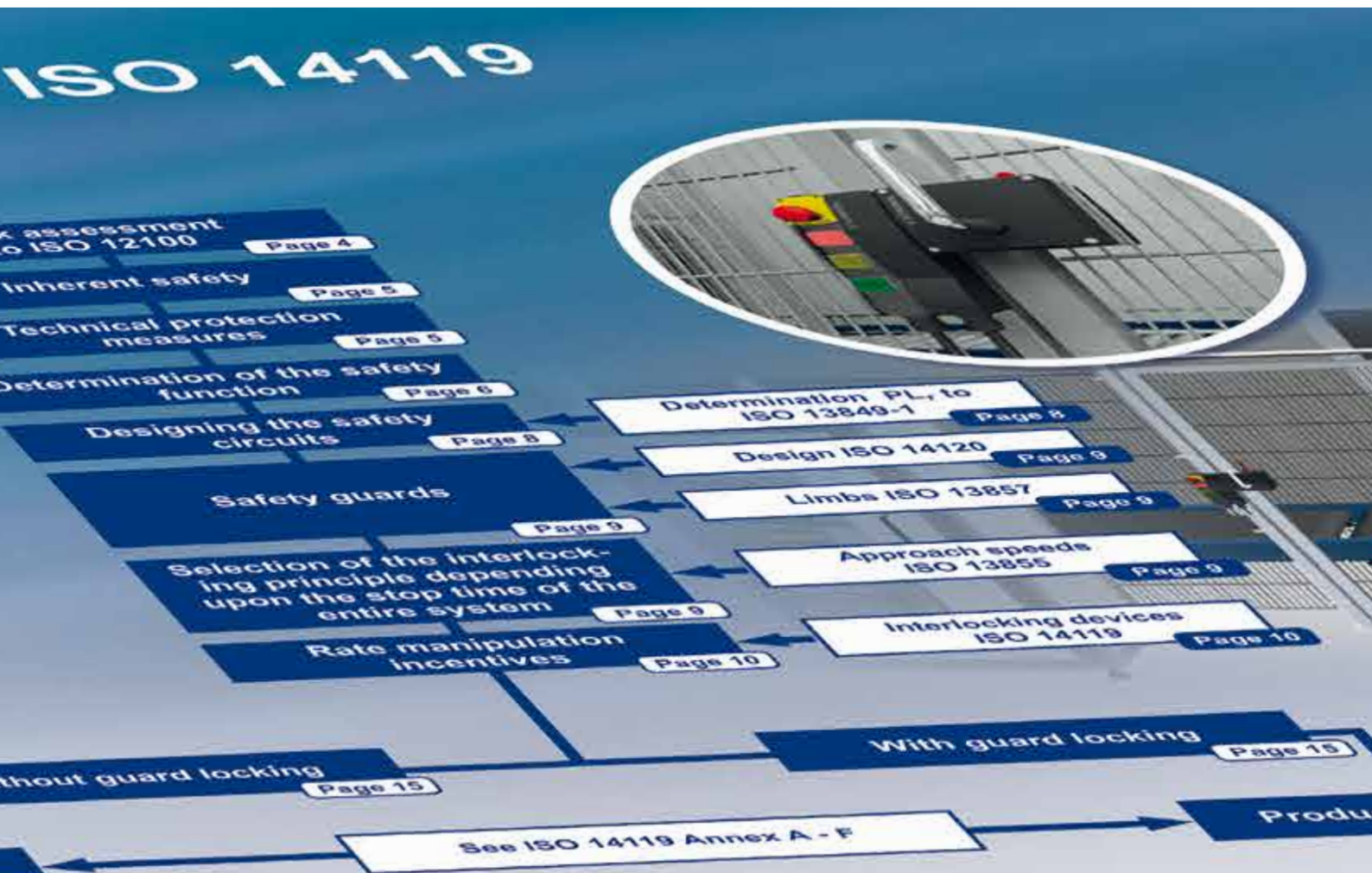

Introduction

With the Machinery Directive (MD) 2006/42 / EC and its associated standards, the European Union has created a set of rules that needs to be considered when designing machinery and plants. This set of rules is also considered and adapted in markets outside the EU as a basis for machine safety. It contains amongst other statements concerning the design of the moveable safety guards.

Position monitoring of moveable guards is described in detail in ISO 14119 "Safety of machinery - Interlocking devices associated with guards - Principles for design and selection" (German version: DIN EN ISO 14119: 2013). This new standard replaces the currently valid EN 1088 and was published on 11 April 2014 in the Official Journal of the European Commission as an European standard harmonised under the MD. As an ISO standard, it is also valid beyond the European Union.

Since the transition period for the implementation of the new standard ends on 30 April 2015, you should already consider this standard during the design of new machines and plants.

This brochure's objective is to aid designers of machinery and plants with standard-compliant design of moveable guards taking into consideration the ISO 14119 and other relevant regulations.

In the centre of the brochure there is an accompanying poster, that gives a quick overview of the technically correct design of moveable safety guards and represents the whole process of their standard-compliant selection and design in the form of a flowchart.

This brochure outlines the enclosed poster and gives detailed information on the individual process steps of the flowchart. The page numbers noted on the poster refer to the relevant page in this brochure, where the process step is described.

The contents of this brochure reflect the interpretation of the Schmersal Group and is also based on the experience gained as a member of the Deutschen Institut für Normung e.V. (German institute for standardisation), Standards Committee NA 095 Safety principles and "Protective devices, safety measures and interlocks". Reading the brochure does not exempt you from your own study and interpretation of the standard.

An initial note on terminology: The term "interlocking device" used in the standard is synonymous for safety switchgear and often leads to confusion, because the term "interlocking device" is generally associated with a component which actually does keep the safety guard locked. From the standard's point of view this component is referred to as interlocking device with guard locking. The interlocking devices themselves, by definition of the standard, only monitor the position (open / closed) of the safety guard. This task can be fulfilled by electromechanical safety switches or non-contact safety sensors.

Content

Introduction	Page 02
1. Risk assessment	Page 04
2. Inherent safety	Page 05
3. Technical protective measures	Page 05
4. Determination of the safety function	Page 06
5. Design of the safety circuits	Page 08
6. Safety guards	Page 09
7. Choosing the locking principle	Page 09
8. Rate defeat incentives	Page 10
9. Interlocking devices with and without guard locking	Page 15
10. Product selection	Page 16
11. Interlocking devices with guard locking with "Power to lock" or "Power to unlock" working principle	Page 18
12. Fault exclusions to ISO 13849-2	Page 19
13. Verification	Page 20
14. Validation	Page 21
15. User information	Page 22
16. List of Standards	Page 23

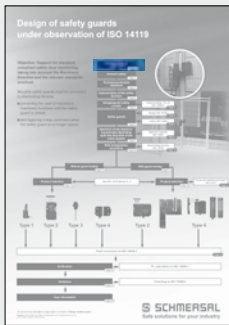

1. Risk assessment

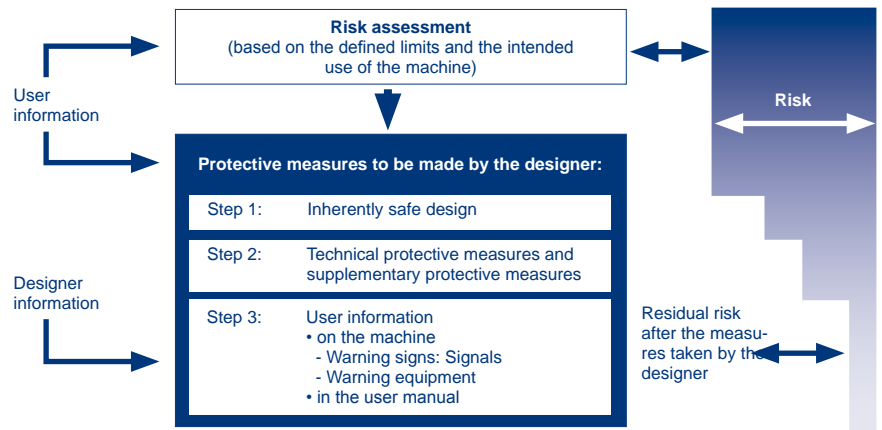

- The MD and therefore the law requires each machine manufacturer to carry out a risk assessment.
- The risk assessment consists of hazard identification, risk estimation and evaluation.
- The risk assessment takes into account the entire life cycle and all operating modes of the machine.
- Instructions for conducting a risk assessment can be found in the ISO 12100.
- Only after completing the risk assessment the manufacturer knows where there are possible risks of injury on the machine and whether anything needs to be done about them.

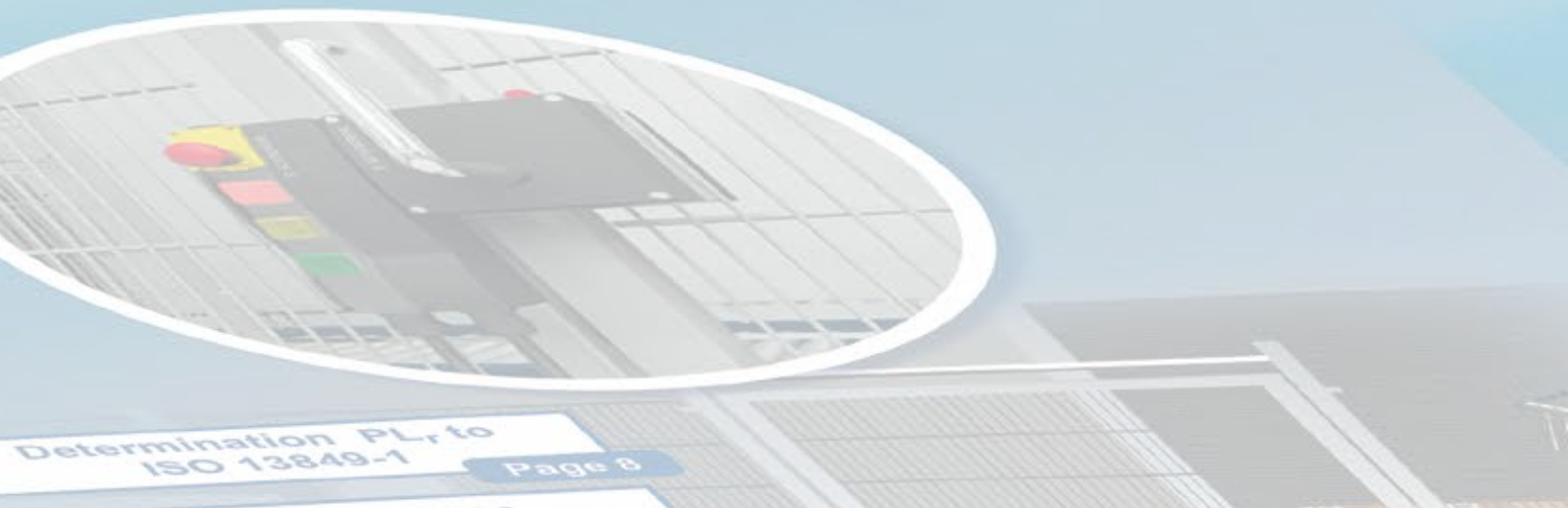

2. Inherent safety

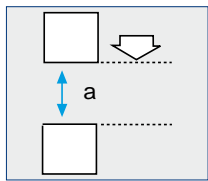

Minimum distances

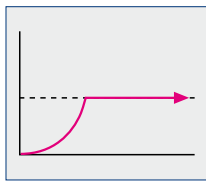

Limiting the effective energy

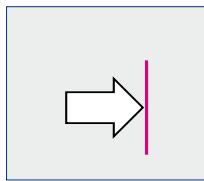

Interrupting the flow of power

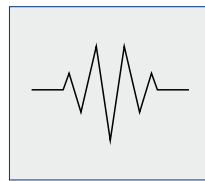

Elastic deformation

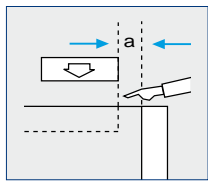

Dangerous movements stop at a distance that cannot deform limbs

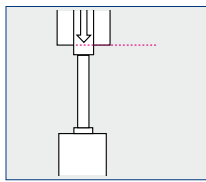

Forces that occur at the hazard spot are to be deliberately limited so as not to have any bodily damaging effect

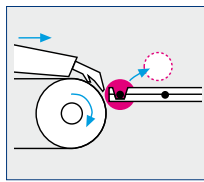

The buildup of forces that would lead to injuries is reliably interrupted before reaching the limits

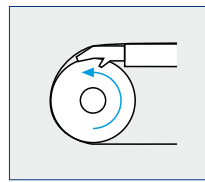

Deliberately resilient machine parts which deform and absorb most of the deforming energy

- According to the image of the ISO 12100, the risks must be constructively eliminated first (= Inherent safety); see ISO 12100, section 3.20.
- Inherent safety is understood to mean the elimination of risks by constructive measures.

3. Technical protective measures



- If the identified risks cannot be eliminated by design measures, or at least minimised to an acceptable level, technical protective measures must be taken such as optoelectronic protective equipment, tactile protective devices, two-hand controls etc., refer to ISO 12100, section 3.21.
- Such a technical protective measure could for example be a movable safety guard. This brochure concentrates on such measures.

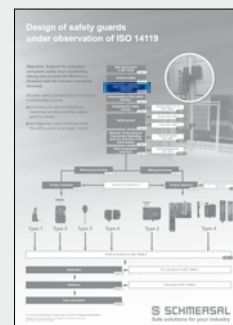
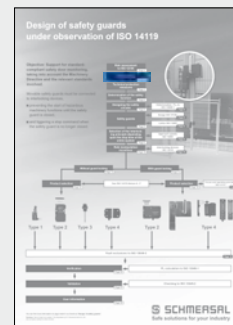

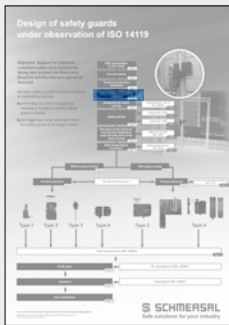

4. Determination of the safety function

- Table 8 of ISO 13849-1 defines safety functions that ensure that the identified risk is minimised, also see ISO 12100, section 30.3.
- When implementing safety functions, the entire safety circuit must be taken into consideration - starting with the sensors (input, in our case the interlocking device), the monitoring device (logic) and the actuator (output).

Every safety function or circuit includes the following components (Sub-systems):

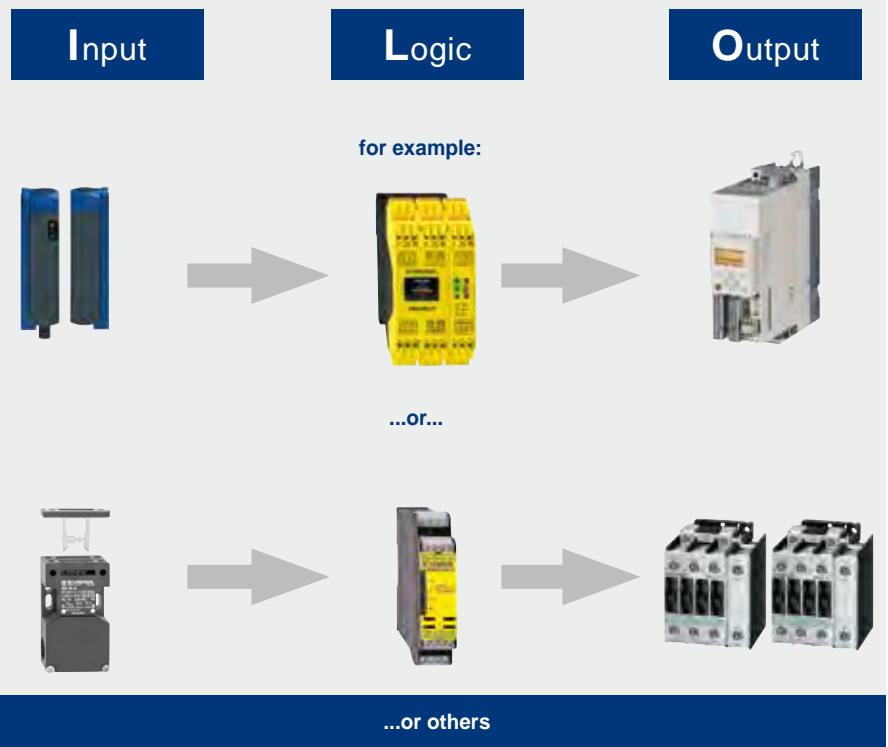

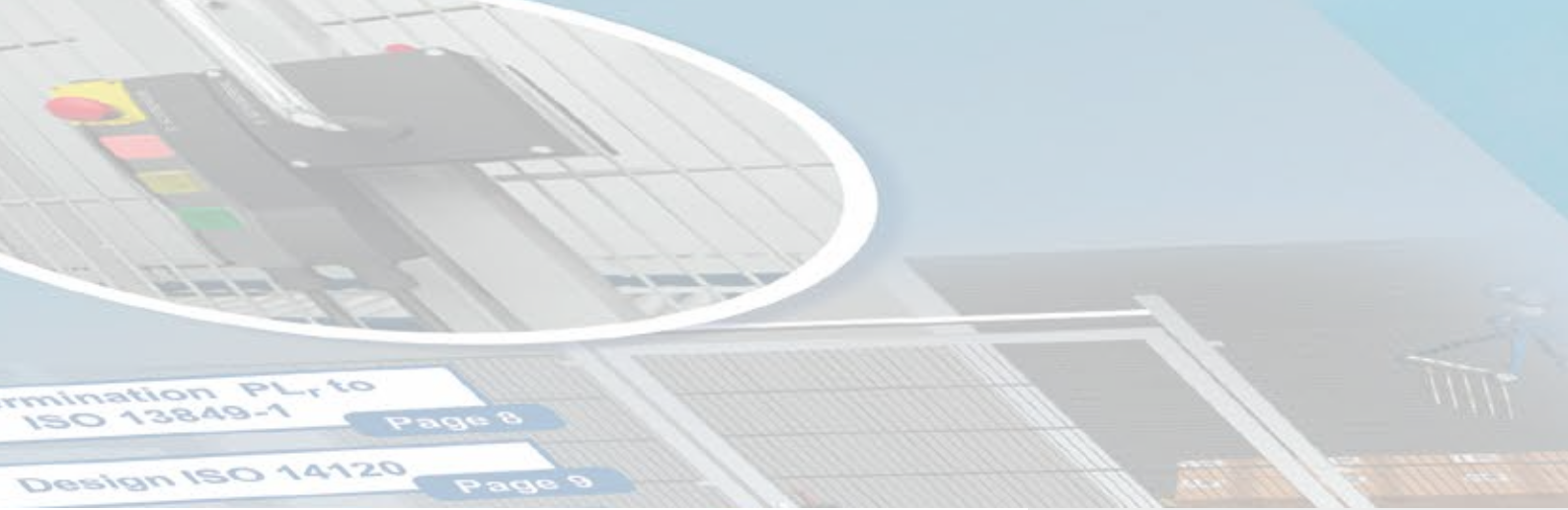

Termination PL_r to ISO 13849-1 Page 8

Design ISO 14120 Page 9

By using the risk graph of ISO 13849-1, Annex A, the required performance level (= PL) can be determined for this safety function.

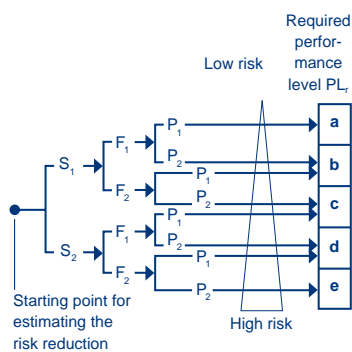

S Severity of injury

- S1 Slight (normally reversible injury)
- S2 Serious (normally irreversible injury or death)

FF Frequency and / or exposure to hazard

- F1 rarely up to less often and / or time of exposure to the hazard is short
- F2 Frequently up to permanently and / or time of exposure to the hazard is long

P Possibility of preventing the hazard or limiting the damage

- P1 possible under certain conditions
- P2 barely possible

The relevant safety functions of movable safety guards are (see ISO 14119, section 3.2):

- Switching off the dangerous machine function when opening the safety guard
- Protection against unexpected start-up
- If necessary, locking the safety door until the dangerous machine function is completed
- If necessary unlocking the guard locking device

The safety function "unlocking the guard locking device" is new. However, the standard assumes (see remarks 1 and 2 of section 8.4.), that the PL of the locking device is less than the PL of the interlocking device. Reason: "The probability of the failure of the interlocking and simultaneous access of a person is very low." (ISO 14119, section 8.4, Note 2.). Nevertheless, inadvertent unlocking of the locking device must be included in the risk assessment.

ISO 14119 takes into account the characteristics and requirements on the sensor (input) of the safety circuit. Their sensor is part of the interlocking device of a safety guard described in the standard.



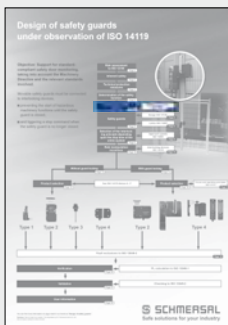

5. Design of the safety circuit

After the safety function has been determined, it is now necessary to design the appropriate safety circuit.

The design is to be in accordance with the requirements of the PLr (see ISO 13849-1, section 6). This means it must meet the requirements of the:

- structure of the safety circuit

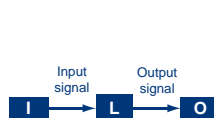

Categories B and 1

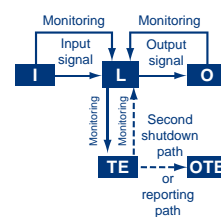

Category 2

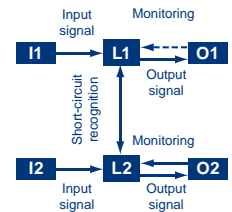

Categories 3 and 4

- expected service life of the components used until the first occurrence of a dangerous fault: $MTTF_d$ (or B_{10d})
- test quality, which means the quality of the dangerous fault detection: DC_{avg}
- measures against common cause failures: CCF

Note to DC_{avg}

- In many applications, the interlocking devices are electrically connected in series. Because of the possibility that dangerous faults that occur may not be detected the DC_{avg} must be correspondingly reduced.
- A technical report currently being prepared (ISO/TR 24119) will give relevant information on series connections of interlocking devices and their effect on the DC_{avg} .

Currently, we recommend that you set the following DC_{avg} :

- Series connection of interlocking devices with positive break contacts: $DC_{avg} = 60\%$ (which still allows a max. performance level of PL d)
- Series connection of magnetic interlocking devices: DC_{avg} dependent on distance of the safety guards and their frequency of operation
- Series connection of self-monitoring electronic interlocking devices: $DC_{avg} = 99\%$ (which allows a max. performance level of PL e)
- Further details on these values, see our information sheet "Estimation of diagnosis degree in series connections of electromechanical safety switches and safety sensors" under <http://series-connection.schmersal.net>



6. Safety guards

The mechanical design of the safety guard is also described by requirements in the following standards:

- ISO 14120: Safety guards**
 There is a reference in section 6.4.4.1 on the access or frequency of access with a movable safety guard indicating when they are to be used. At a frequency of more than once a week a movable guard should be used with an interlocking device to ISO 14119.
- ISO 13857: Safety distances to prevent hazardous areas being reached by the upper and lower limbs.** This standard describes the sizes of limbs and consequently the necessary safety distances to hazardous areas. It states amongst others in section 4.3, that guards should not exceed a ground clearance of 180 mm, because this would allow the whole body to access the hazardous area.

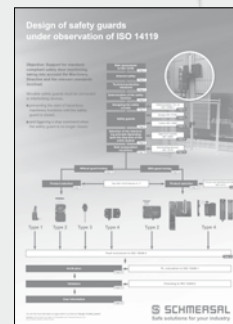
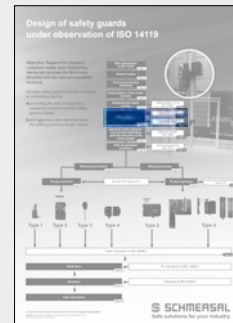

7. Choosing the locking principle

The type of locking device, that should be used, i.e. with or without guard locking can be determined by using the flow chart of the ISO 14119.

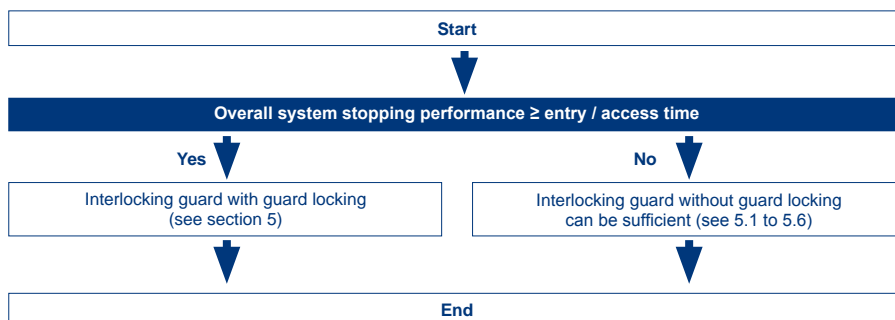

Information to answer the question whether the stop time of the whole system is \geq entry / access time is given in the standard ISO 13855 section 9.

- This given standard calculates the safety distance from behind the safety guard to the danger zone with an entry speed of 1600 mm/s or an access speed of 2000 mm/s.
- The safety distance is also dependent on the size of the body parts that obtain access to the danger zone when the safety guard is opened. Therefore, the standard ISO 13857 is also to be considered when calculating the stopping time.



8. Rate defeat incentives

An investigation has showed that accidents are often the result of protective equipment being defeated. Therefore an essential focus of ISO 14119 is the prevention of the interlocking devices from being tampered with. To prevent this the standard suggests a certain method in the form of a flowchart.

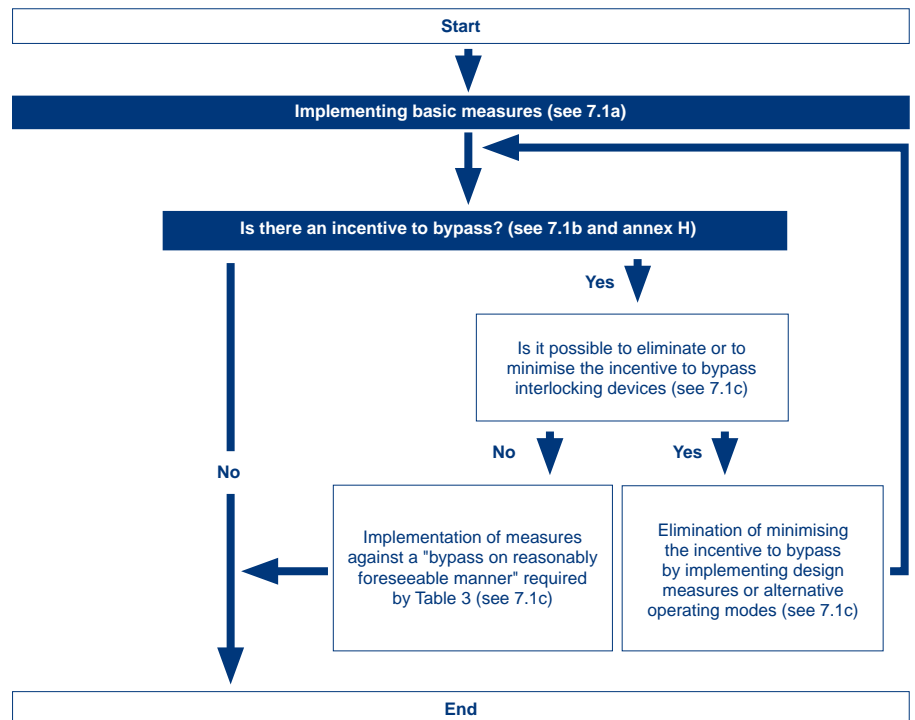
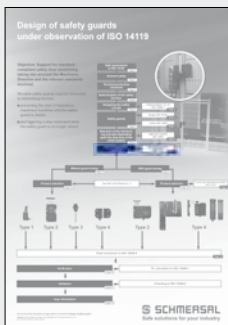

The goal of this method is to recognise the defeat incentive and to reduce or eliminate it.

The ISO 14119 also supports the designer with determining the defeat incentive. It suggests a matrix that shows the task to be carried out on the machine and the consideration of easing the task through corresponding defeat.



Thus, it is readily apparent, at what point and in which task or operating mode of the machine there is a risk of defeat.

Task	Operating mode 1 ^a	Operating mode 2 ^a	Operating mode 3 ^a	Operating mode 4 ^a	Operating mode 5 ^b	Allowable tasks for this operation mode?	Tasks possible without bypassing?	Easier / more convenient ^b	Quicker / high productivity ^b	Flexibility, such as with larger work pieces	Higher level of precision ^b	Improved visibility ^b	Improved audibility ^b	Less physical effort ^b	Less travel ^b	Larger freedom of movement ^b	Better flow of movement ^b	Prevention of interruptions ^b	...	
Commissioning																				
Program test / Test run																				
Installation / adjustment / modification / equipping																				
Processing																				
Manual intervention for removal of debris																				
Manual changing of work-pieces																				
Manual intervention with troubleshooting																				
Check / random sampling																				
Manual intervention with measurement / fine adjustment																				
Manual tool change																				
Maintenance / Repair																				
Fault rectification on machine																				
Cleaning, e.g. removing debris																				

Tab. 2 Example of an assessment of incentives to bypass interlocking devices (Source: ISO/DIS 14 119, Table H.1).

Of course, this table is to be adapted to the respective application or machine.

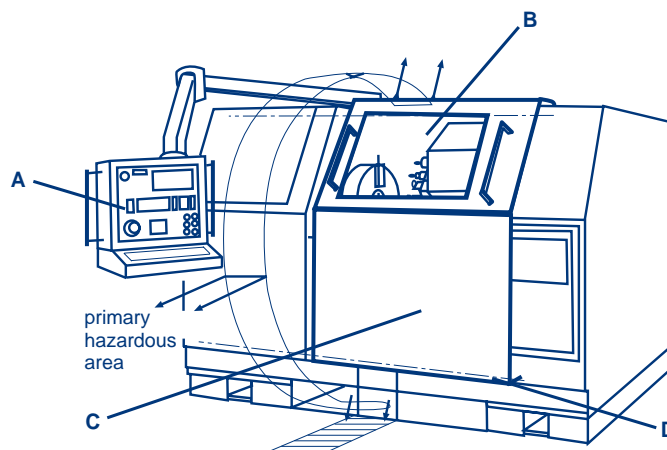

If it is determined that defeat incentives exist, then these must first be eliminated by design, see ISO 14119, section 7.1 c. Examples of purely constructive measures are:

A) Ergonomics:

- Height adjustment of the control panel
- Arrangement and design of the display and operating elements
- Position of the emergency stop switch
- Observability of the working zone
- Dimensions and location of the handles
- Manual forces for displacing

B) Viewing window:

Window construction: Polycarbonate - window must be protected against chemical and abrasive influences from inside with a safety glass pane and from the outside should be protected with a non-splintering plastic pane or splintering prevention foil.

Window mounting: The mounting should be able to withstand high impact reaction forces, allow considerable deforming and at the same time the ends of the polycarbonate window should be hermitically sealed against chemical reaction.

C) Protective cover:

Cover structure: With sandwich construction, the inner skin must be extremely deformable, and the outer skin designed to be extremely resistant and stiff.

Main closing edge: With power-operated safety doors the kinetic energy and speed when closing must be limited so that no dangerous pinching point is created at the main closing edge. The effective closing force must not exceed 150 N.

Cover mounting: Guidance on rollers in form-fitting custom runners. Clamps prevent ejection of the cover if damaged. The lower area of the cover should be designed that neither debris nor cooling lubricant can escape outwards.

D) Controllers:

Functional safety: Reliable fulfilling of safety functions within a defined period of time with the safety relevant part of the controller.

Defeat prevention: Interlocking elements non-accessibly mounted with tamperproof screws if necessary. Safety concept harmonised with activity in all service life stages of the machine.



Principles and measures

	Type 1-Interlocking device (except when hinge-operated) and Type 3-Interlocking devices	Type 1-Interlocking device (operated only with hinge)	Type 2- and Type 4-Interlocking device with low or middle coding level according to 7.2 b) 1) or 7.2 b) 2) with or without solenoid latching	Type 2- and Type 4-Interlocking devices with high coding level according to 7.2 b) 3) with or without solenoid latching!	Key transfer systems (with middle and high coding level, see note 2)
Mounting out the reach, see 7.2 a) 1)					
Barrier / shielding, see 7.2 a) 2)					
Mounting in hidden location, see 7.2 a) 3)			X		
Condition monitoring or periodic examination, see 7.2 d) 1) i) and ii)	X				
Non-releasable attachment of position switches and actuators, see 7.2 c)					
Non-releasable attachment of the position switch, see 7.2 c)		M			M
Non-releasable attachment of the actuating element, see 7.2 c)		M	M	M	M
Additional interlocking device and plausibility checks, see 7.2 d) 2)	R		R		

- X The application of at least one of these measures is mandatory
- M Mandatory measure
- R Recommended measures (additional)



In ISO 14119 section 5 very general requirements for the installation and mounting of interlocking devices are described which must be observed regardless of the measures described in Table 3 above:

Section 5.2: Arrangement and mounting of position switches

Position switches must be arranged so that they are adequately secured against their position being changed. To achieve this, the following requirements must be met:

- The fasteners of the position switches must be reliable and to remove them, a tool is required.
- Type-1-position switches must have a method to permanently secure the position after adjustment (such as bolts or dowel pins).
- The facilities required for access to the position switches for maintenance and verification of the correct operation must be ensured. Avoidance of dealing in reasonably foreseeable way is also to be considered when designing the access.
- Gradual loosening must be prevented.
- Bypassing the position switch in a reasonably foreseeable way must be prevented (see section 7).
- The position switches must be arranged and, if necessary, be protected in such a way to prevent damage by unforeseen external causes.
- The movement caused by the mechanical operation or the distance to the actuating system of a non-contact position switch must remain within the actuating area of the position switch specified by the switch manufacturer or the actuating system, this is to ensure proper operation and/or to prevent an overrun.
- A position switch should not serve as a mechanical stop, unless this is the intended use of the position switch according to the manufacturer.
- Misalignment of the guard, caused by an opening before the position switch state changes should not affect the protective effect of the safety device (regarding access to hazardous areas, see ISO 13855 and ISO 13857).
- The receptacle and the mounting of the position switches must be sufficiently stable to maintain proper operation of the position switch.

Section 5.3: Arrangement and mounting of actuators

Actuators must be secured so that the possibility of becoming loose or the possibility of modifying its intended position relative to the actuating system is reduced to a minimum over the intended service life.

- The fasteners of the actuators must be reliable and to move them, a tool is required.
- Gradual loosening must be prevented.
- The actuators must be arranged and, if necessary, be protected in such a way to prevent damage by unforeseen external causes.
- An actuator should not serve as a mechanical stop, unless this is the intended use of the actuator according to the manufacturer.
- The receptacle and the mounting of the actuator must be sufficiently stable to maintain proper operation of the actuator.

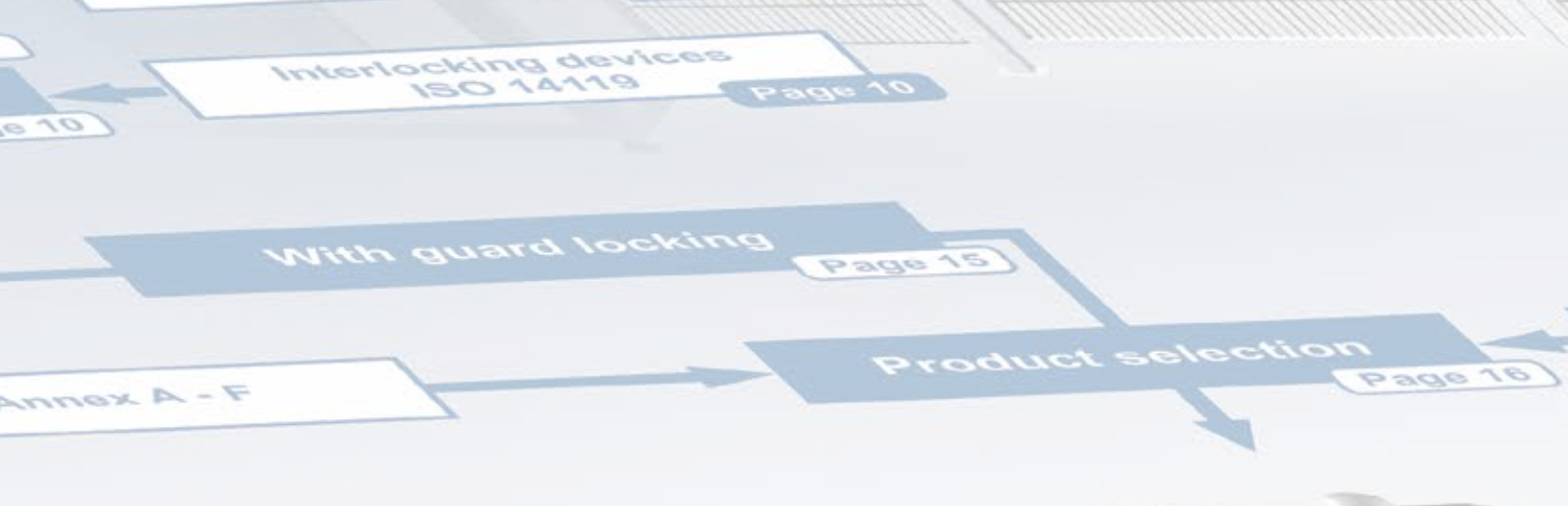

Given the procedure described above and the protective purpose of this standard, it is our opinion that a position switch may be mounted with standard screws, if neither a defeat incentive exists, nor a standard screwdriver belongs to the normal operating tool of the machine.

9. Interlocking devices with and without guard locking

The standard distinguishes four different types of interlocking systems:

Type 1
uncoded



Type 2
coded



Type 3
uncoded



Type 4
coded



The coding level is not important. When considering the designs, the first consideration is whether the interlocking device is at all coded or not.

The following coding levels are defined in the standard (see section 3.13.1 to 3.13.3):

- low:** Coding options: 1 - 9
- medium:** Coding options: 10 - 1,000
- high:** Coding options: > 1,000

This definition is independent of the locking function of the interlocking device.

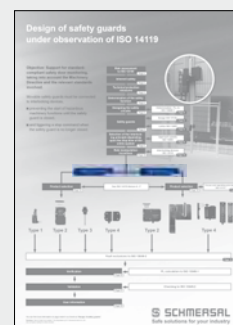



Type 3

Type 4

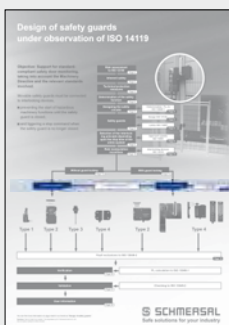

10. Product selection

The selection of the appropriate product always depends of course on the real application, i.e. operating conditions, such as:

- Temperature
- Humidity
- Dirt
- Shock/vibration
- Explosive atmosphere
- Necessary holding force

Further details and application instructions for the different types described above are given in annexes A - F of the standard.

The selection of a product also depends on the PL, to be achieved (see above page 7). ISO 14119 and ISO 13849-2 prescribe redundancy of Type 1 or Type 2 switches when the PL_r = PL e is to be reached (see ISO 14119 section 8.2 and ISO 13849-2, table D.8).

ISO 14119 /
ISO 13849-2:
Redundancy

IEC 60947-5-3:
Product standard
of safety
sensors

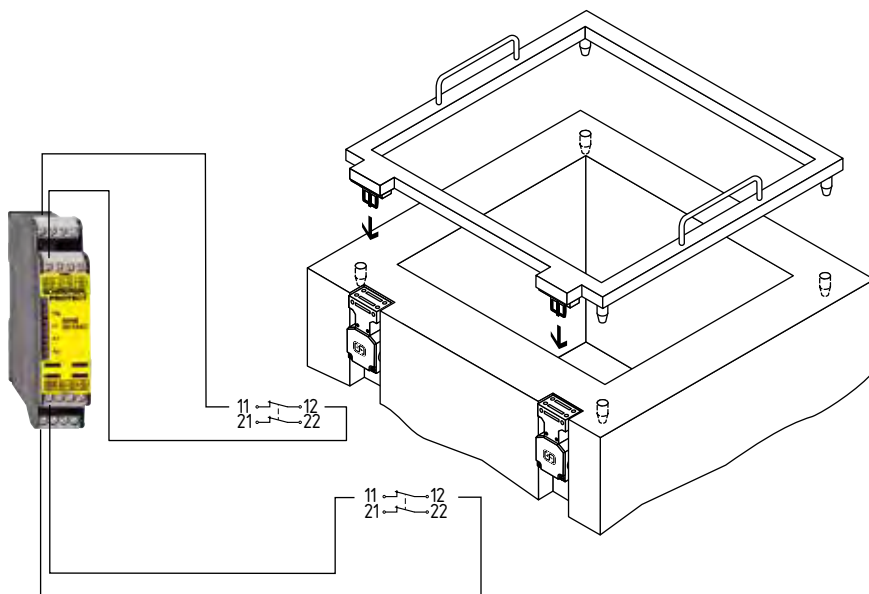

If a safety sensor (Type 3 or Type 4) is being used - that allows to use only one to achieve PL e in contrast to Type 1 or Type 2 switches (see above) - make sure that this sensor fulfills the requirements of the product specific standard IEC 60947-5-3 (see ISO 14119 section 5.4)

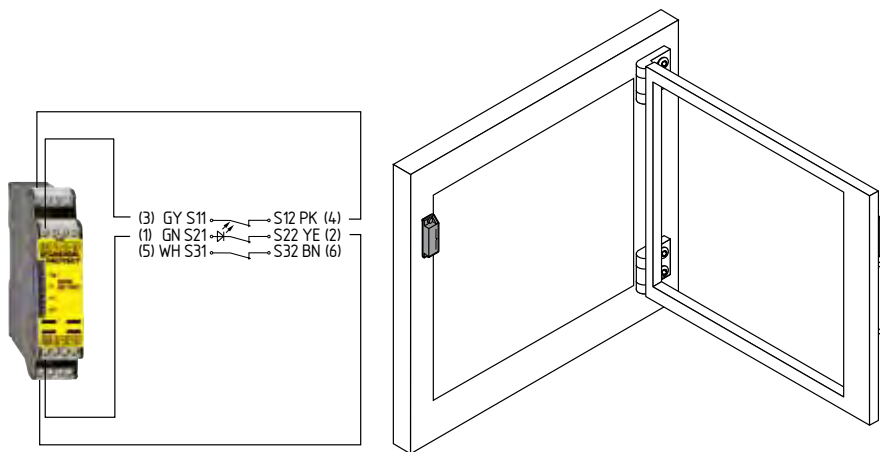
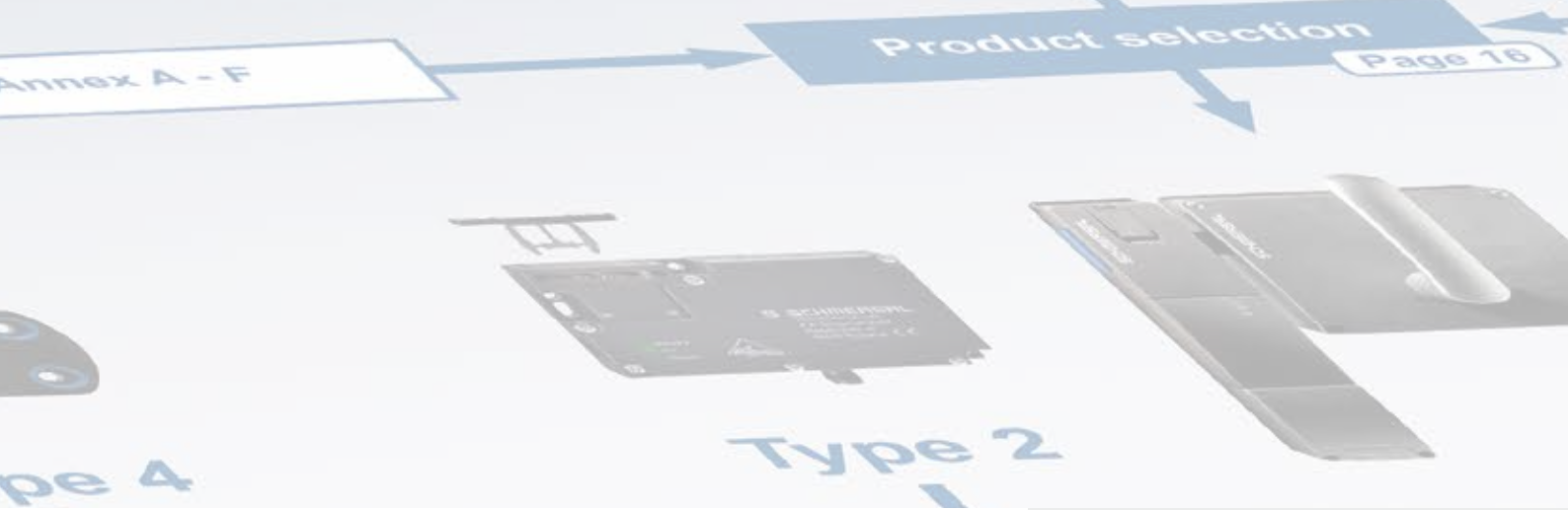

If, because of the stopping time described above, an interlocking device with guard locking is required, then Annex I is to be observed. It informs about the maximum possible static action forces that may be posed on interlocking devices with guard locking feature. As an informative annex and as an exemplary enumeration it is to be understood as a guideline of possible maximum force levels (ie: orders of magnitude) are represented. The locking forces actually required in a real application cannot and will of course not be prescribed by the standard. Here, either the machine manufacturer or a type C standard (also see section 6.2.2 Note 2) should be consulted.

If an interlocking device with a guard locking is used, a manual (deliberate) deactivation of the guard locking device should be considered for installation, maintenance or repair work purposes on the machine.

Such types of release are defined in the standard ISO 14119 section 3.25 to section 3.27:

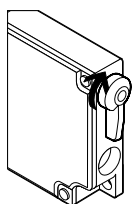

■ Emergency release: mounted outside the hazardous area, for emergency use

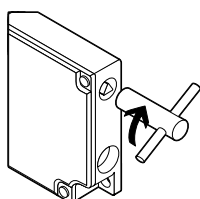

■ Auxiliary release: for unlocking during setup, no emergency

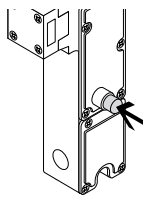

■ Escape release: mounted within the hazardous zone to be able to leave the area independently in the event of danger

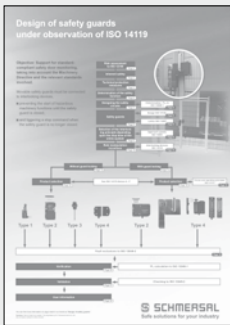
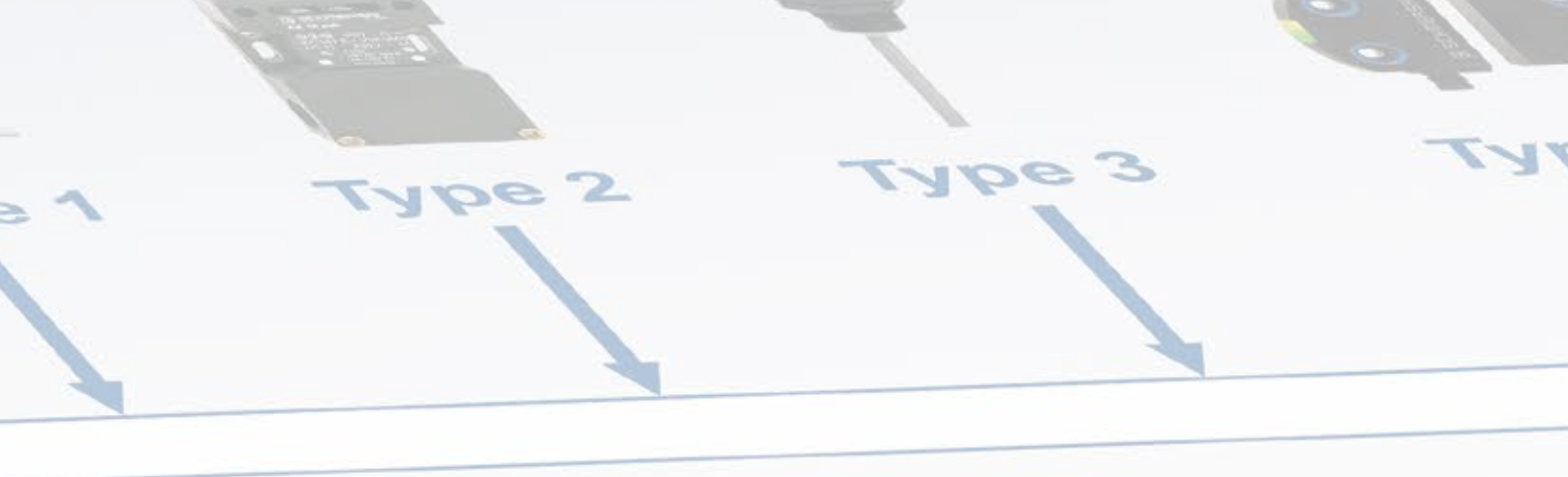

11. „Power to lock“ or „Power to unlock“ working principle

Depending on whether energy is needed to lock or unlock the safety door, one distinguishes between

- Power to unlock: mechanically locked, unlocked by applying energy (see A)
- Power to lock: energy required to keep locked, release by removing the energy (see B and D)

For safety reasons, the power to unlock (quiescent current) principle is preferable. After a proper risk assessment the power to lock principle may also be applied. Accordingly interlocks are often used with the power to unlock principle for personal protection and interlocks with the power to lock principle for process protection (also see section 3.28 and section 3.29)

A)		Power to unlock	Locked
		Energy ON unlocked	Unlocked
B)		Energy ON locked	Locked
		Power to lock	Unlocked
C)		Energy ON locked	Locked
		Energy ON unlocked	Unlocked
D)		Energy ON locked	Locked



12. Fault exclusions

Machine safety requires the correct functioning of the safety circuit. It is therefore of utmost importance that any errors that could occur leading to a loss of safety are excluded.

The central standard that deals with possible errors in the components of a safety circuit, is the ISO 13849-2.

In the annexes, possible errors and possible exclusions due to the application of certain techniques are described in tabular form. For example: The non-opening of an electro-mechanical contact can be excluded by using a switch with positive break contacts.

It is important to study the applicable tables of the standard (especially Annex D: Validation tools for electrical systems) and document possible fault exclusions.

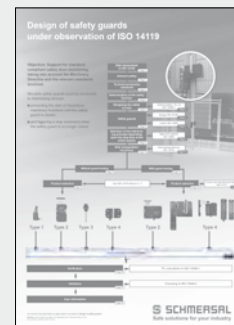

Verification

Validation

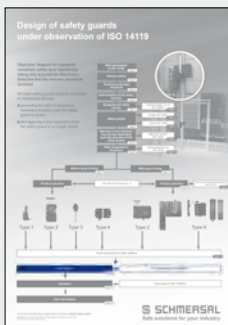

ISO 13849-1:
Verification

13. Verification

The verification is used to provide evidence that the selected components and their inter-connections are sufficiently resistant to systematic and random errors that would result in the loss of the safety function. This is accomplished using a PL-calculation that must also include the corresponding monitoring device and the actuator. This calculation process is described in ISO 13849-1.

Calculation of the safety function

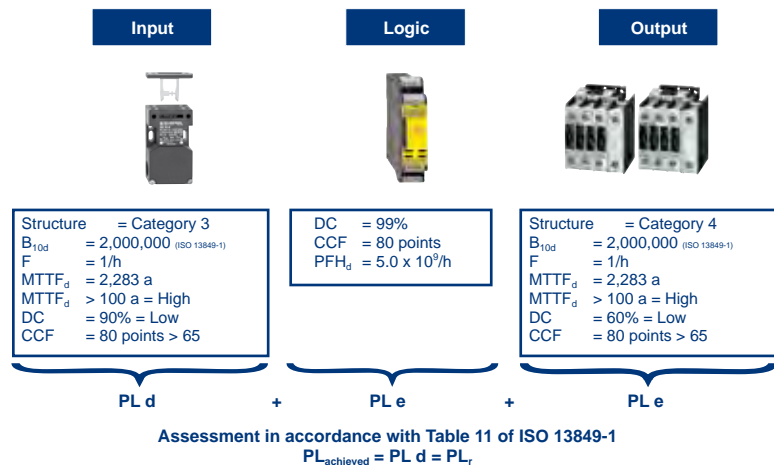

Such calculations can be performed on the computer with the SISTEMA software tool provided free of charge by the BIA. The software is available for download at: <http://sistema-en.schmersal.net>

Many manufacturers of safety components make the data of their components available in so-called SISTEMA libraries. The Schmersal library is available at: www.schmersal.net

Further information and calculation examples can be found in:

- 1) Our brochure: "Background information to EN ISO 13849-1:2006"
<http://iso13849-en.schmersal.net>
- 2) BIA Report for 13849-1
<http://bia-en.schmersal.net>
- 3) In the SISTEMA "Cookbooks":
<http://sistema-book.schmersal.net>



- 1)
- 2)
- 3)

14. Validation

Despite all care, a final check of all conditions and parameters is mandatory, see ISO 13849-1, image 3. How to proceed with the validation, is described in ISO 13849-2. The procedure shown there is as follows:

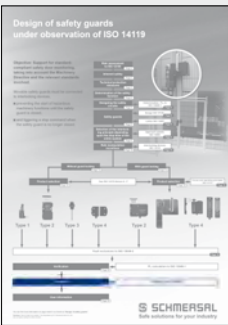
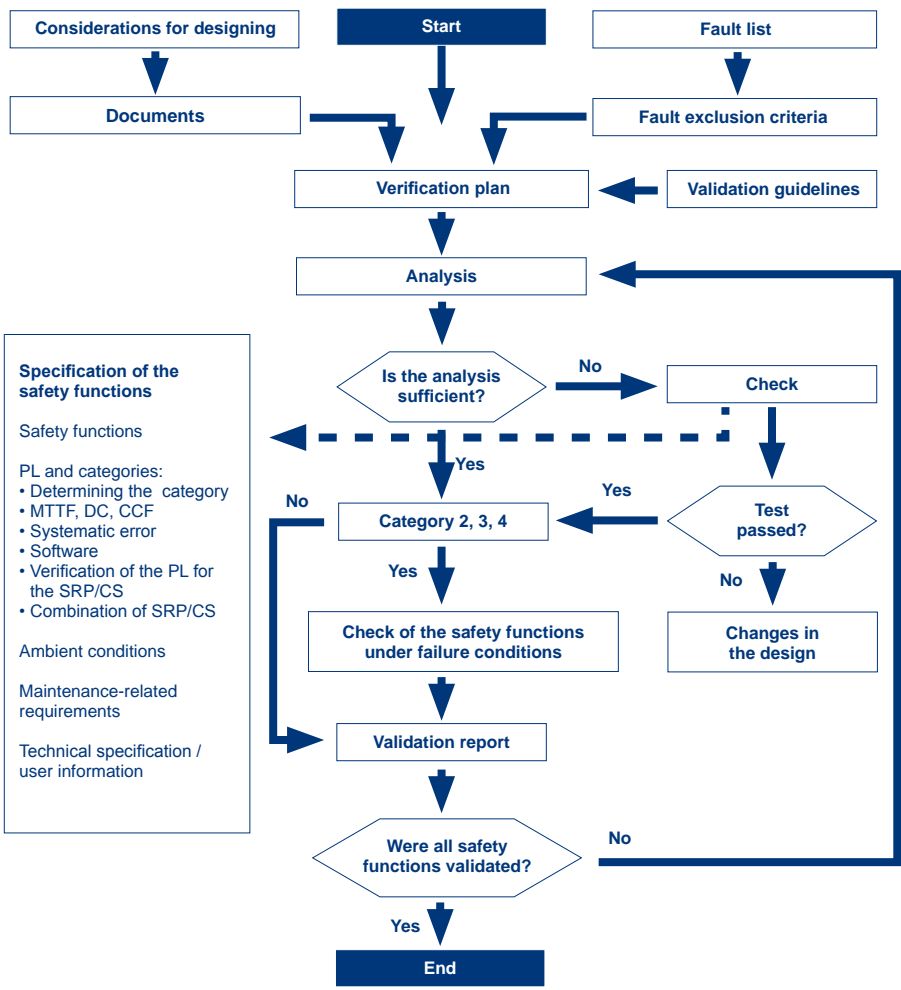

Verification

Validation

User information



Hence it does not only depend on the theoretical analysis, but depending on the complexity of the machine, also on the practical check of the safety function.

For a practical check of a two-channel machine it can be useful to deliberately disconnect one channel and then test the reaction of the system.

Here it is again important to record the results (validation report).

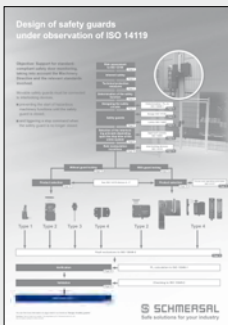

15. User information

If, in spite of all protection measures there are still remaining risks at the safety guard available (such as with certain operating modes, e.g. maintenance operations, setting up) it is essential that the user is informed.

This can take place in two different ways: on the safety guard itself and in the operating instructions for the machine.

However, at this point it must be made clear that this is the last possibility for risk reduction that may be used after the inherent construction (see page 5 of this brochure) and also the technical protection measure (ie: locking the safety guard) have been exploited.

Information on creating standardised operating instructions can be found in ISO 12100 section 6.4 and also in IEC 82079-1.

ISO 12100:
Operating
instructions

IEC 82079-1

16. List of Standards

MD 2006/42/EC	Machinery Directive of the European Parliament and of the Council of 17 May 2006 on machinery, and amending Directive 95/16/EC
ISO 12100:2010	General principles for design - Risk assessment and risk reduction
ISO 13849-1:2006	Safety of machinery - Safety-related parts of control systems - Part 1: General principles for design
ISO 13849-2:2012	Safety of machinery - Safety-related parts of control systems - Part 2: Validation
ISO 13855:2010	Safety of machinery - Positioning of safeguards with respect to the approach speeds of parts of the human body
ISO 13857:2008	Safety of machinery - Safety distances to prevent hazard zones being reached by upper and lower limbs
ISO 14119:2013	Safety of machinery - Interlocking devices associated with guards - Principles for design and selection
ISO/DIS 14120:2013	Safety of machinery - Guards - General requirements for the design and construction of fixed and movable guards
ISO/DTR 24119	Safety of machinery - Evaluation of fault masking serial connection of guard interlocking devices with potential free contacts (draft)
IEC 60947-5-1:2003	Low-voltage switchgear and control gear - Part 5-1: Control circuit devices and switching elements - Electromechanical control circuit devices
IEC 60947-5-3:2013	Low-voltage switchgear and control gear - Part 5-3: Control circuit devices and switching elements - Requirements for proximity devices with defined behaviour under fault conditions (PDDB)
IEC 82079-1:2012	Preparation of instructions for use - Structuring, content and presentation - Part 1: General principles and detailed requirements

Finally with this brochure we hope to have given you helpful tips with the standard-compliant construction of protective devices. We have created the content of this brochure and the poster to the best of our knowledge and belief, but assume no responsibility for their content. We also wish to point out the standardisation in European and at international level are in constant change in order to keep in line with the technical progress and to adapt the standards and regulations to this new technology.

If you have any questions or suggestions, we would be happy that you contact us. If you require more information please refer to our current event and training program, which can be viewed under www.technikum.schmersal.com. Additionally our staff are available with further information.



The Schmersal Group

For many years the privately owned Schmersal Group has been developing and manufacturing products to enhance occupational safety. What started out with the development and manufacture of a very wide variety of mechanical and non-contact switchgear has now become the world's largest range of safety systems and solutions for the protection of man and machine. Over 1,500 employees in more than 50 countries around the world are developing safety technology solutions in close cooperation with our customers, thus contributing to a safer world.

Motivated by the vision of a safe working environment, the Schmersal Group's engineers are constantly working on the development of new devices and systems for every imaginable application and requirement of the different industries. New safety concepts require new solutions and it is necessary to integrate new detection principles and to discover new paths for the transmission and evaluation of the information provided by these principles. Furthermore, the set of ever more complex standards, regulations and directives relating to machinery safety also requires a change in thinking from the manufacturers and users of machines.

These are the challenges which the Schmersal Group, in partnership with machinery manufacturers, is tackling and will continue to tackle in the future.

Product ranges



Safe switching and monitoring

- Guard door monitoring safety switches
- Command devices with safety function
- Tactile safety devices
- Optoelectronic safety devices

Safe signal processing

- Safety monitoring modules
- Safety controllers
- Safety bus systems

Automation

- Position detection
- Command and signalling devices

Industries



- Elevators and escalators
- Packaging
- Food
- Machine tools
- Heavy industry

Services



- Application advice
- CE conformity assessment
- Risk assessment in accordance with the Machinery Directive
- Stop time measurements
- Training courses

Competences



- Machine safety
- Automation
- Explosion protection
- Hygienic design

Precautions have been taken to assure accuracy of the information in this catalogue. Typographic or pictorial errors that are brought to our attention will be corrected in subsequent issues.

www.schmersal.com



Design of safety guards under observation of ISO 14119

Objective: Support for standard-compliant safety door monitoring, taking into account the Machinery Directive and the relevant standards involved.

Movable safety guards must be connected to interlocking devices,

- preventing the start of hazardous machinery functions until the safety guard is closed,
- and triggering a stop command when the safety guard is no longer closed.



You can find more information on page noted in our brochure "Design of safety guards".

Disclaimer: Does not claim to be complete. The interpretation by K.A. Schmersal GmbH & Co. KG does not replace reading the relative standard.