

SLC/SLG 440
Compact Safety Light Curtains and Grids

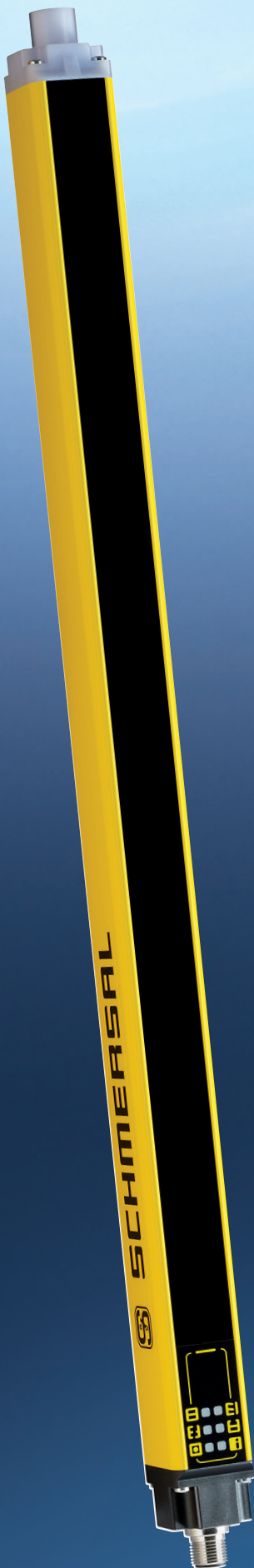



SLC/SLG 440

One Design

■ **User Friendly:**

No controller required
No programming software
Integrated Alignment Aid

■ **Compact Design:**

28mm x 33mm housing

■ **Performance**

Rapid response time
Superior mechanical strength
Horizontal applications

■ **Quality**

Designed to meet the latest
international safety standards
EN ISO13849-1, EN 62061, cULus,
EN 61496-1, CLC/TS 61496-2, TUV

Multiple Solutions

- **Multifunctional:**

- Fixed and Floating Blanking,
 - Finger, Hand and Body Protection

- **Unique Features**

- Prominent OSSD Status Indication
 - Double Reset
 - Blanking with Movable Edge

- **Maximum Strength:**

- Seamless One Piece Construction

- **Minimize Downtime**

- Visual diagnostics
 - 7 segment message display
 - Quick and easy program configuration





Optoelectronic safety sensors

The SLC/SLG 440 product series is an efficient solution for automated process cycles, offering the highest protection for user and machine. It provides a smooth and flexible adaptation to any machine concept by means of the integrated functions, which can be configured without any tools (PC / software). The protective targets can be smoothly and effortlessly implemented if changes to the process lead to modified settings such as fixed and floating object blanking with variable periphery (movable edge). The integrated set-up tool and status indication (7 segment display) reduce installation expenditures and keeps the operator informed of the current operating status when the machine is running.

- Process safety with highest availability
- Reliable safety concept in case of interferences (EMC, welding sparks)
- User-friendly parameter setting, no tools required
- Integrated set-up tool

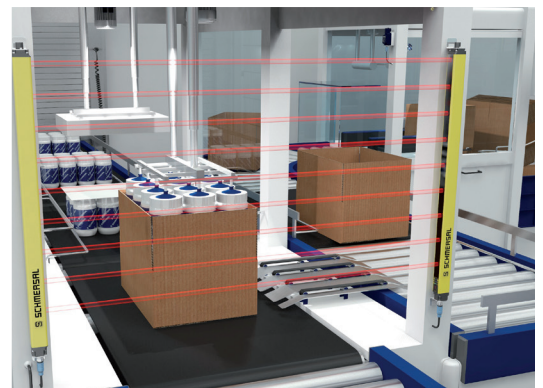
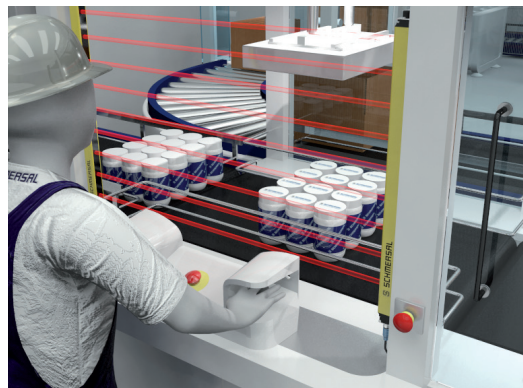

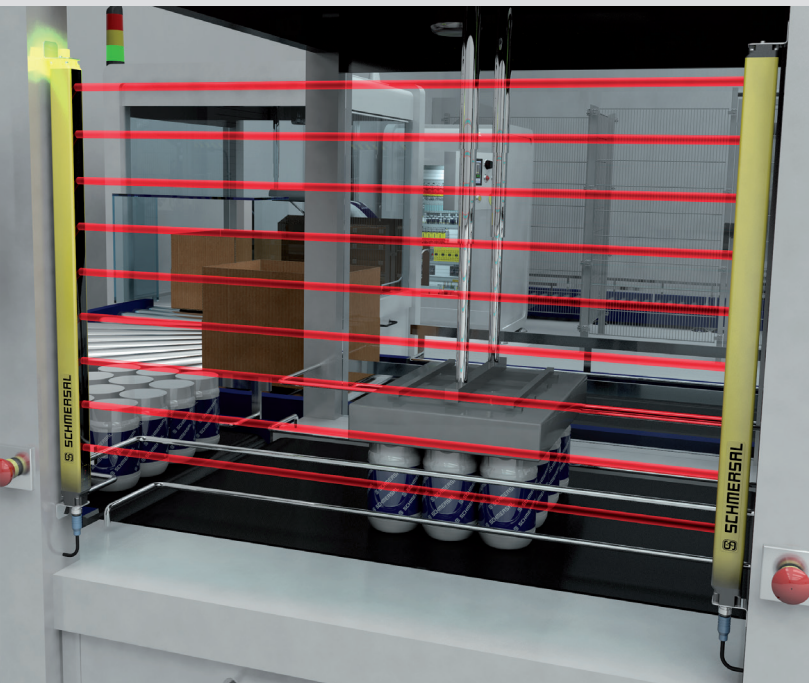

Hazardous point protection with SLC 440

Profitable hazardous point protection featuring low space requirements, undisturbed access to the process and highest safety level SIL 3 / PL e

- For the safe detection of fingers, hands, or limbs
- Shortest safety distances, very fast response time
- Visualisation through large status indication
- Safe evaluation with output cyclic test

Area protection with SLG 440

The SLG 440 light grid can be used for the protection of areas and accesses. It provides for a profitable and safe monitoring of large hazardous areas.

Fields of application

- Power-driven machines
- Power presses in the metal and plastics industry
- Folding or brake presses and cutters
- Filter presses, punching machines
- Robot cells and welding booths
- Printing machines and injection molding machines
- Materials handling and storage technology
- Handling and assembly technology
- Palletizers
- Packaging equipment

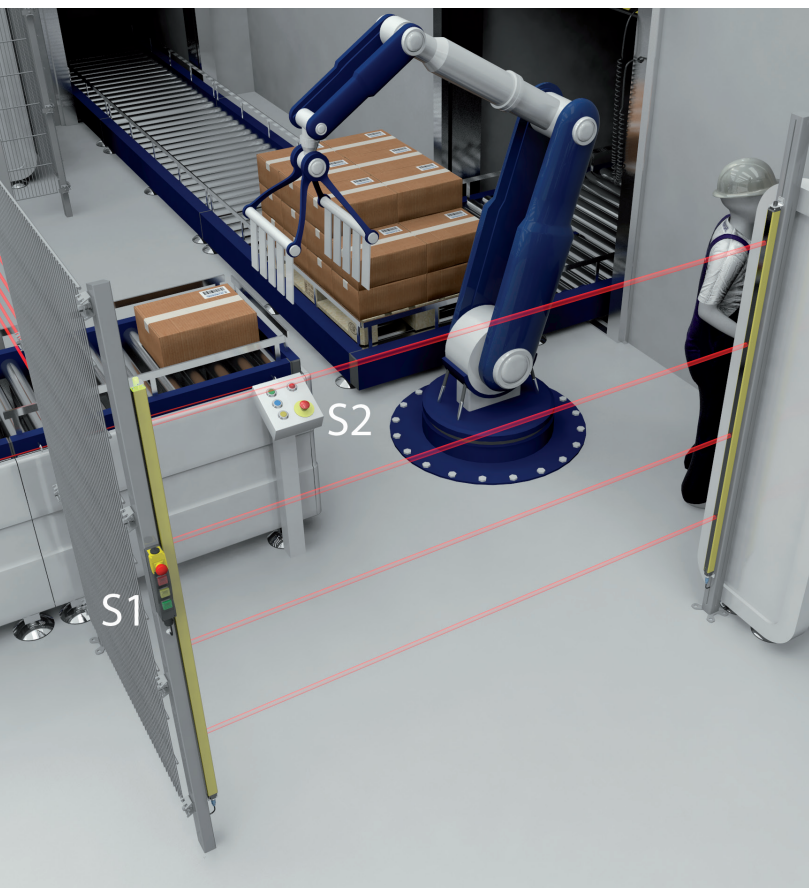

NEW function: double reset

Large production areas that are partially visible can present multiple risks. An unsafe restart of the machinery can occur when third parties push the reset button with workers remaining within the protected hazardous area.

The solution: the SLC/SLG440 integrates a double reset function.

As soon as a person enters the hazardous area, the hazardous movement is stopped by interrupting the light curtain or grid beams. To restart the machine, the operator first must actuate the command device S2, located inside the hazardous area; then when he has left the area, the operator actuates the command device S1.

SLC/SLG 440

Safety and profitability - that is what many manufacturers promise. However, we are the only one, who can offer one product featuring this variety of integrated functions without external tool.

- Automatic and restart interlock mode
- EDM contactor control
- Double reset
- Fixed and floating object blanking
- Blanking with movable edge region
- Beam coding
- Status and diagnostic indication
- Integrated set-up tool
- Integrated alignment aid

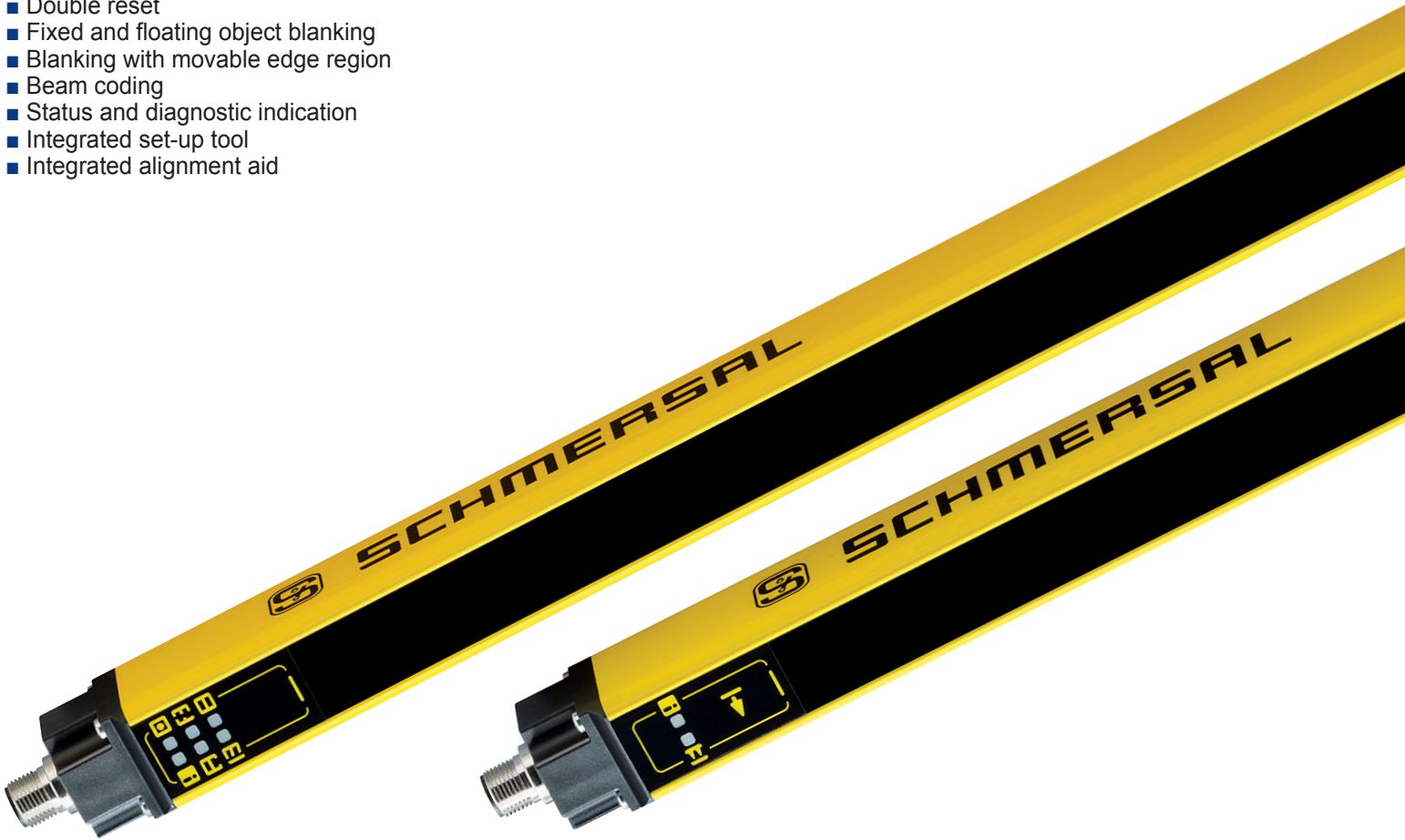

Compact, slim design (width 28 mm)

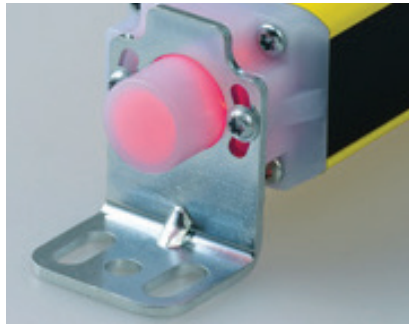

Mounting:

- Smooth fitting, 360 degrees adjustable
- Robust, reinforced angle bracket (included in delivery)
- High stability in case of vibrations

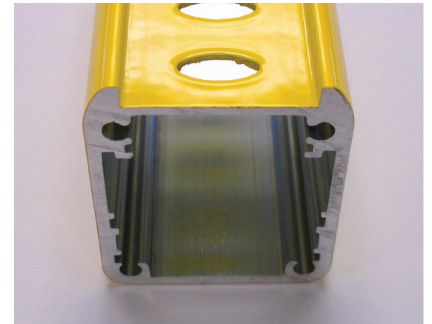

Profile system:

- Stable, robust, closed profile
- Front cover protected against mechanical stress

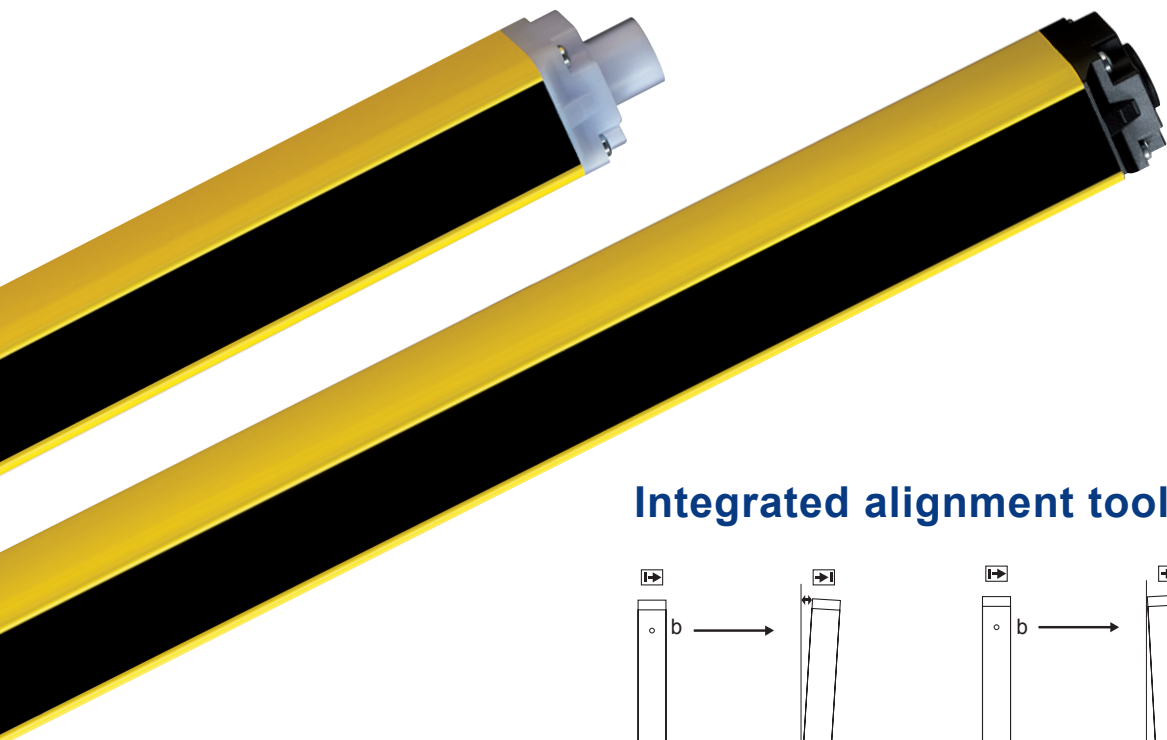

Integrated alignment tool

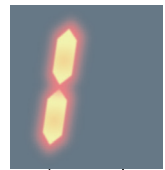
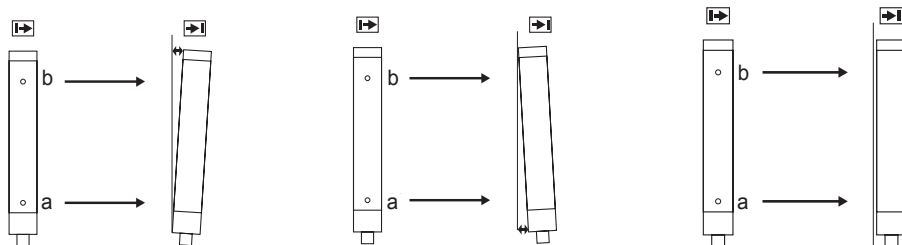

a good
b missing



a missing
b good



a good
b good

a = Second beam
b = Last beam

Output or OSSD status indication

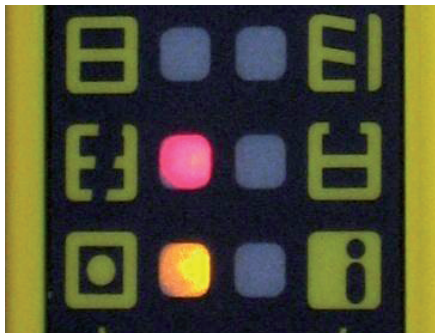

LED status:

- OSSD ON
- OSSD OFF
- Restart interlock release
- Signal quality
- Blanking
- Information



OSSD status:

- Enabling signal

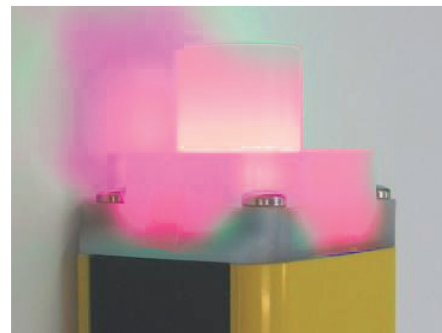

OSSD status:

- Enabling signal required

- Status indication of the system visible over a long distance
- Status indication with protection class IP67
- Glass-fibre reinforced fixing unit

Parameter setting

Simple and quick – without tool

The function selection is implemented in parameter setting mode. To that effect, the 7-segment display offers a parameter selection, which is selected in a user-friendly manner by means of a command device (button/enabling switch) instead of a PC and software and permanently saved.

Program example - activating external device monitoring (EDM)



Contactor control not active

- Press pushbutton x3 to reach Program 4
- P4- indicate Program 4 (EDM) is inactive



Contactor control active

- Push and hold pushbutton for 2.5s to 6s to change setting
- P4A indicates Program 4 is active



Save new configuration

- press pushbutton x3 to reach the Save functions indicated by the letter S
- Push and hold pushbutton for 2.5s to 6s. to save the configuration.



Contactor control function available

- Reconnect SLC/SLG440 back to the safety system

Advantages:

- Simple menu navigation
- Very fast implementation
- No tools required
(PC, software, external parameter setting tools)

Available programming options:

- Fixed blanking
- Fixed blanking with movable edge
- Floating blanking
- External Device Monitoring (EDM)
- Double reset
- Beam coding
- Diagnostic/setting mode



Safety light curtains and safety light grids

SLC 440

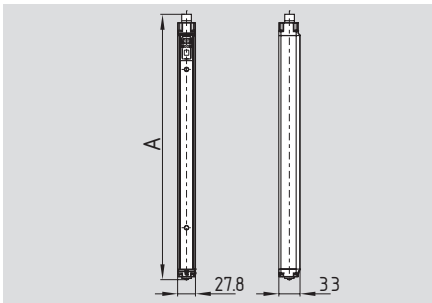

• Safety light curtain

- Type 4 to EN 61496-1, CLC/TS 61496-2
- Resolution 14 and 30 mm
- Protection field heights 170 mm ... 1770 mm
- Integrated start/restart interlock
- Integrated contactor control
- Integrated blanking function (fixed and floating blanking)
- Diagnostic and parametrization interface
- Range 0,3 m ... 10 m
- Fail-safe transistor outputs
- Optical synchronisation
- LED Status display, 7-segment display
- Protection class IP67
- Double reset

Legend: A = Total length

A = 81 mm + Protection field height

Approvals



Ordering details

SLC 440-E/R①-②-01

No.	Option	Description
①	xxxx	Protected heights (mm) available lengths: 0170, 0250, 0330, 0410, 0490, 0570, 0650, 0730, 0810, 0890, 0970, 1050, 1130, 1210, 1290*, 1370*, 1450*, 1530*, 1610*, 1690*, 1770*
②	14	Resolution 14 mm with a range of 0.3 m ... 7 m
	30	Resolution 30 mm with a range of 0.3 m ... 10 m

-01 = integrated status indication

* only for resolution 30 mm

SLG 440

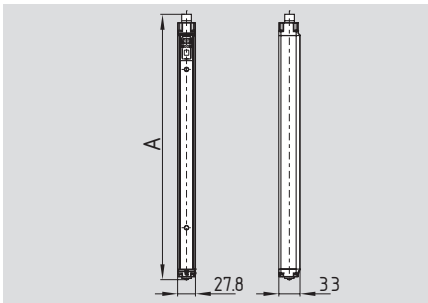

• Safety light grid

- 2-, 3- or 4-beam light grid
- Range 0,3 ... 12 m

Legend: A = Total length

2-beam A = 610 mm

3-beam A = 910 mm

4-beam A = 1010 mm

Approvals



Technical data

Standards: EN 61496-1; CLC/TS 61496-2
 Category: Type 4
 Enclosure: aluminium
 Enclosure dimensions: 27.8 x 33 mm
 Connection: Connector plug
 - Emitter: M12, 4-pole,
 - Receiver: M12, 8-pole
 Max. cable length: 100 m / 1 Ω
 Protection class: IP67 to EN 60529
 Response time: 10 ... 27 ms (depends on length and resolution)

Detection sensitivity (Resolution): 14 and 30 mm
 Protection field height:
 - Resolution 14 mm 170 ... 1210 mm
 - Resolution 30 mm 170 ... 1770 mm
 - 2-, 3-, 4-beam 500, 800, 900 mm
 Protection field width, Range:
 - Resolution 14 mm 0.3 m ... 7 m
 - Resolution 30 mm 0.3 m ... 10 m
 - 2-, 3-, 4-beam 0.3 m ... 12 m
 Start/restart interlock: Integrated
 Contactor control: Integrated
 Blanking function: Integrated
 Light emission wavelength: 880 nm (infrared)
 U_e: 24 VDC ± 10%
 Safety outputs: 2 x PNP, 250 mA
 Power consumption: Emitter 1,8 W, Receiver 3,8 W
 Status and diagnostics: LED-, 7-segment display
 Ambient temperature: -10 °C ... +50 °C
 Storage and transport temperature: -25 °C ... +70 °C

Classification:

Standards: EN ISO 13849-1; EN 62061
 PL: up to e
 Category: up to 4
 PFH-value:
 - SLC 440 11,4 x 10⁻⁹ /h
 - SLG 440 8,14 x 10⁻⁹ /h
 SIL: up to 3
 Service life: 20 years

Ordering details

Connector:

Female connector M12, 4-pole straight

for emitter

cable length 5 m **KA-0804**
 cable length 10 m **KA-0805**
 cable length 20 m **KA-0808**

Female connector M12, 8-pole straight

for receiver

cable length 5 m **KA-0904**
 cable length 10 m **KA-0905**
 cable length 20 m **KA-0908**

Cable for the parametrization

cable length 1 m **KA-0974**

Mounting hardware included

Definitions and terms:

AOPD

The abbreviation for **Active Opto-electronic Protective Device**.

OSSD

The abbreviation for **Output Signal Switching Device** of the AOPD (to IEC 61496)

Optoelectronic safety devices

Electronic devices that emit and/or detect light signals. A coded infrared signal is transmitted from the emitter unit and the receiver detects any obstruction in the protected field. These devices provide a non-separating or "virtual" safety guard.

Safety Light Curtain

A multi-beam AOPD, used for point of hazard protection

Safety Light Grid

A 2-, 3- or 4-beam AOPD, used for perimeter guarding to detect the passage of personnel into a hazardous area.

Protection field:

The two dimensional area between the emitter and receiver units of the safety light curtain that the infrared beams cross, defined in length by the Range and in height by the Protected Height.

Protected height:

The distance between the first and last infrared light beams of an opto-electronic safety device. (not the total housing length)

Range:

The distance between the light curtain emitter and receiver units.

Resolution:

The distance between adjacent infrared beams, defined in millimeters. This represents the minimum object sensitivity or size of an object that is detected in the protection field.

Type 4

According to IEC 61496-1, a protective device whose safety function is not affected by a failure or error in the system. These devices must meet the requirements of Control Category 4 which can be used in applications up to PLe/SIL3.

Blanking:

This function allows objects to be passed through the protection field without deactivating the light curtain safety outputs or OSSD.

Fixed Blanking:

When a fixed set of adjacent light beams are rendered inactive for the purpose of passing an object through the protection field.

Fixed blanking with movable edge:

Allows for a tolerance of +/- 1 beam for a fixed set of blanked light beams.

Floating Blanking:

When a set number (one or more) of adjacent beams anywhere in the protection field is allowed to ignore the presence of an objects passing.

Double Reset

A sequence requiring a reset button to be actuated followed by the actuation of a second reset button within a specific amount of time before a machine can re-initiated.

EDM:

The abbreviation for **External Device Monitoring**. When the auxiliary contacts of a positively linked motor control relay / contactor is being monitored to assure that the linked safety contacts are functioning.

Restart interlock:

A device preventing the automatic restart of the machine, when the protection field is interrupted during a dangerous machine cycle or when the operating mode of the machine is set or changed

Start interlock:

A device preventing the automatic release and therefore the automatic machine start when the power supply of the AOPD is switched on or interrupted and switched on again.

NOTES

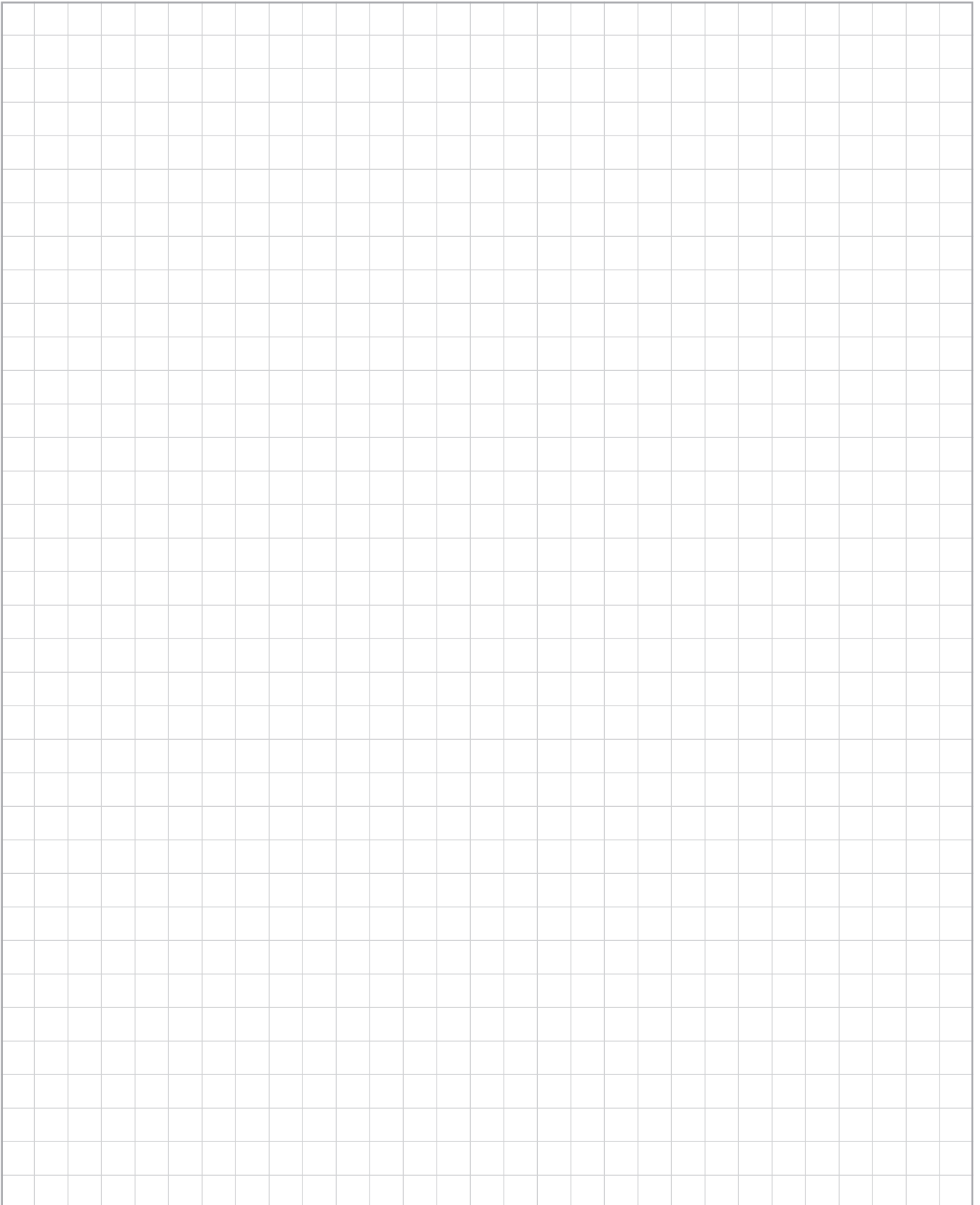

SLC/SLG Type 2/4 Opto-Electronic Product Family

The Schmersal group offers a wide selection of Opto-Electronic safety devices which are designed to help solve application challenges for industry while enhancing operator safety.

- IP69K rating for high pressure & high temperature washdown applications
- Integrated Muting with direct sensor connection
- Long Range for applications up to 40m
- Master Slave connections
- Retro reflective light grids
- Compact design 12mm x 20mm

The available features from the Schmersal opto-electronic family provide our customers multiple options when selecting the appropriate product for any application.



SCHMERSAL
USA

15 Skyline Drive
Hawthorne, NY 10532

Tel: (914) 347-4775
Fax: (914) 347-1567
E-mail: salesusa@schmersal.com
www.schmersalusa.com



SCHMERSAL
Canada

15 Regan Road, Unit #3
Brampton, Ontario L7A 1E3

Tel: (905) 495-7540
Fax: (905) 495-7543
E-mail: salescanada@schmersal.com
www.schmersalcanada.ca